



HURRICANE

CUSTOM CANOPIES



☎ 407.212.0048
✉ HurricaneCustomCanopies@gmail.com
🌐 HurricaneCustomCanopies.com
📷 @HurricaneCustomCanopies



Custom Canopy Tents



- 1 An effective display to showcase your promotion information.
- 2 Weather resistant & durable fabric allows you to enjoy a long lasting use.
- 3 Custom graphics, elegant outlook and crisp color help you stand out.

Customize A Tent Top For Your Frame

Besides standard sized tents like 10'x10', 10'x15', 10'x20', etc, we also offer matching print service for all types of tent hardware.



4 easy steps to customize a tent top for your frame

STEP 1



Select a tent frame type

STEP 2



Submit your tent frame dimensions

STEP 3



An exclusive product generates under your account

STEP 4



Purchase the customized tent top online

3 Types of Tent Frames



Single Toppest Pole Frame



Double Toppest Pole Frame

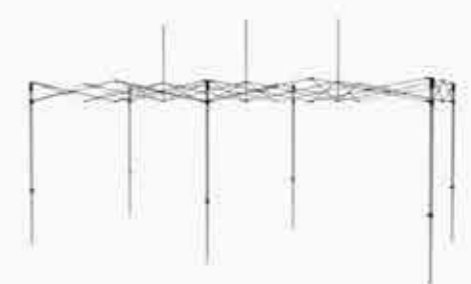

Triple Toppest Pole Frame

Create Your
Unique Product

Customize To Meet Any Need

Tent Top

The durable advertising tent is an effective marketing tool for both indoor and outdoor activities. The strong and upscale hex frames allow you to enjoy a steady display.



- Available sizes: 5'x5', 6.5'x6.5', 10' x10', 10' x15', 10' x20', 13'x13', 13'x20', 13'x26', 20'x20'...
- Dye sublimation printing method is adopted.
- Suggested product uses: indoor exhibitions, outdoor events, promotional activities.

- BEST SELLER
- QUICK SHIP
- Machine Wash, Gentle
- FAST COLOR
- WRINKLE -FREE
- SETUP VIDEO



Advertising tent is one of the most popular display solutions for almost all kinds of events and activities. When setting up such a custom printed canopy at your event site, you can not only mark your marketing space, but also catch more attentions.

● **Material:**
600D PU Polyester

● **Lead Time:**
24H/48H

● **Size:**
5'x5' 10'x15' 13'x20'
6.5'x6.5' 10'x20' 13'x26'
10'x10' 13'x13' 20'x20'

10x10 TOP SELLER
Advertising Tent (SKU:ATT-10)

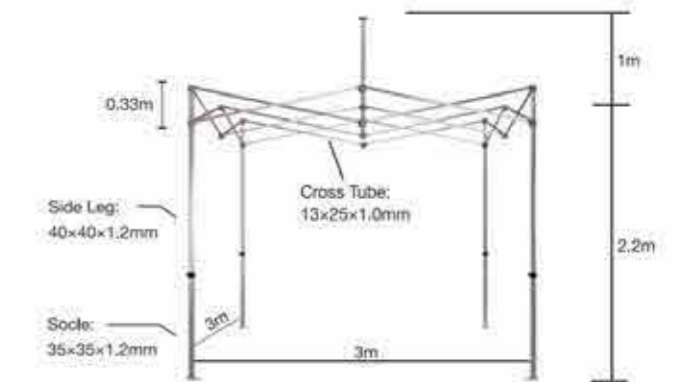

10x15 HOT SELLER
Advertising Tent (SKU:ATT-15)

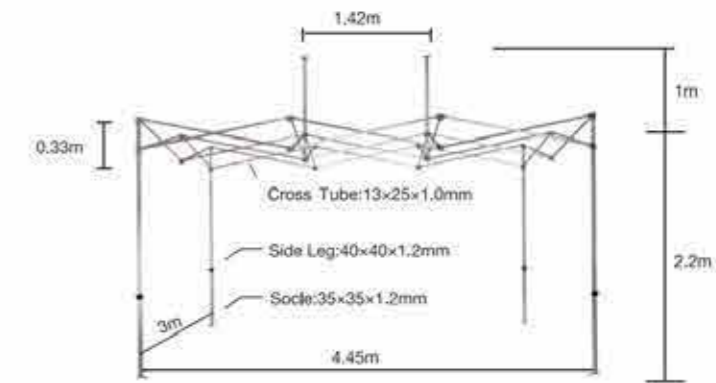

10x20 HOT SELLER
Advertising Tent (SKU:ATT-20)

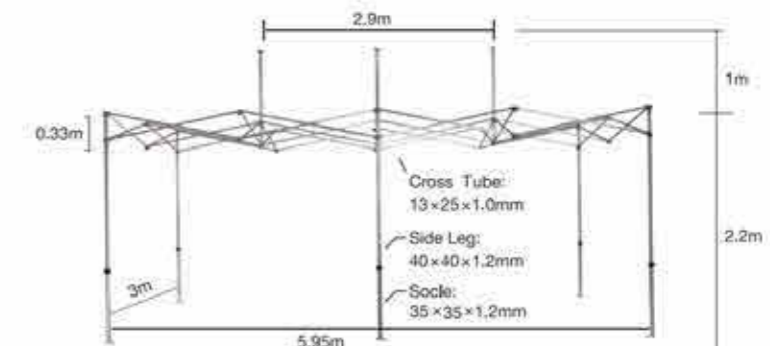

Small Size Tents



◀ 5x5 Advertising Tent (SKU:ATT-5)



6.5x6.5 Advertising Tent (SKU:ATT-6.5) ▶

Large Size Tents



13x13 Advertising Tent (SKU:ATT-13)



13x20 Advertising Tent (SKU:ATT-13x20)



13x26 Advertising Tent (SKU:ATT-13x26)



20x20 Advertising Tent (SKU:ATT-20x20)



Tent Frame (SKU:ATFS/ATFH)

This internal frame is an excellent design that is simple to put together, with slide joints. It breaks down into manageable sections for convenient transport.

- **Material:** Aluminum
- **Type:** 40mm / 50mm
- **Size:**
 - 5'x5' 10'x15' 13'x20'
 - 6.5'x6.5' 10'x20' 13'x26'
 - 10'x10' 13'x13' 20'x20'
- **Lead Time:** 24H / 48H

40mm Hex Frame VS 50mm Hex Frame

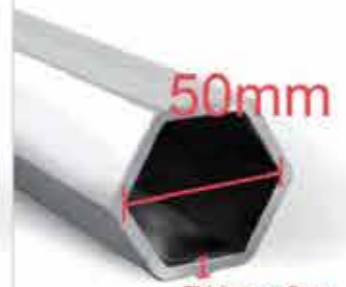
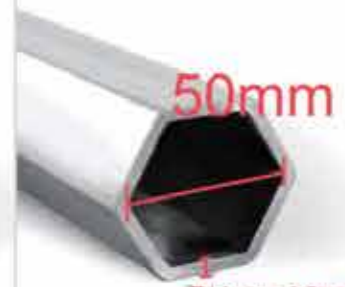
Specification\Type	40mm Hex Tent Frame (5x5/6.5x6.5/10x10/10x15/10x20)	50mm Hex Tent Frame (1) (10x10/10x15/10x20)	50mm Hex Tent Frame (2) (13x13/13x20/13x26/20x20)
Material	Aluminum		
Leg Shape	Hexagonal		
Details of Leg			
Tube Diameter	40mm	50mm	50mm
Tube Thickness	1.2mm	2mm	1.8mm
Weight	Standard	Heavy	Heavy
Stability	Good	Excellent	Excellent
Recommended Use Occasions	Our most popular one. Strong and sturdy, it is good for both indoor and outdoor use.	The most strong and also the most expensive one. More recommended for outdoor use.	Larger sizes are optional. Ideal for outdoor events.

Direct ship from USA warehouses, save UP TO 50% on shipping!

* Visit our website for inventory info

Advertising Tent Package

- BEST SELLER
- QUICK SHIP
- Machine Wash, Gentle
- FAST COLOR
- WRINKLE -FREE
- SETUP VIDEO



Click "More Option", you'll see side wall options.

1 Tent Top+1 Full Back Wall+2 Half Side Walls +1 Frame+1 Wheel Bag

- **Material:**
600D PU Polyester
- **Lead Time:**
24H / 48H



1 Tent Top+1 Full Back Wall+1 Frame +1 Wheel Bag

- **Material:**
600D PU Polyester
- **Lead Time:**
24H / 48H



1 Tent Top+2 Half Side Walls+1 Frame +1 Wheel Bag

- **Material:**
600D PU Polyester
- **Lead Time:**
24H / 48H

Half Wall & Full Wall

- BEST SELLER
- QUICK SHIP
- FAST COLOR
- WRINKLE -FREE
- SETUP VIDEO

Full wall and half wall are usually used to add extra space for your branding and create a clean, enclosed sales area for merchandise, or separate your booth from others.

- Dye sublimation printing method is adopted
- Single-sided and double-sided options available
- Suggested product uses: They can be freely matched to suit your different occasions, such as outdoor promotion stores and indoor trade shows



Half Wall (SKU:ATHW)

The half wall is always used as a side wall that can be freely matched to suit your different occasions, such as outdoor promotion store and indoor trade show.

- **Material:**
600D PU Polyester
 - **Lead Time:**
24H/48H
- **Size:**
 - 5FT 6.5FT
 - 10FT 13FT
 - 20FT



Full Wall (SKU:ATFW)

The full wall is always used as a back wall. With large printing size, the full walls are perfect when it comes to creating a closed and clear marketing area.

- **Material:**
600D PU Polyester
 - **Lead Time:**
24H/48H
- **Size:**
 - 5'x5' 10'x15' 13'x20'
 - 6.5'x6.5' 10'x20' 13'x26'
 - 10'x10' 13'x13' 20'x20'

Custom Size Full Wall (SKU:ATCSFW)

Besides standard size like 10ft, 15ft and 20ft, etc. we can also do the full walls custom size to match your other sized canopy tents.

- **Material:**
600D PU Polyester
- **Lead Time:**
24H/48H
- **Size:**
Custom Size



Blank Half Wall (SKU:ATBHW)

Half wall, also called half sidewall, can be used to create a clean, enclosed sales area for merchandise, or separate your booth from others. A half-wall can be easily attached to the tent frame with a durable aluminum bar.

- **Material:**
600D PU Polyester
420D PVC Polyester
- **Lead Time:**
24H/48H
- **Size:**
10FT

Full Wall (Single PVC Window) (SKU:ATMFWS)

Whether you are selling food or your hand made items we provide a high quality long lasting durable tent for all your event needs. This full wall with PVC window can let customers see your product clearly while setting a protecting shield between you.

- **Material:**
Full Wall: 600D PU Polyester
Window: PVC
- **Lead Time:**
24H/48H
- **Size:**
10'x10'
10'x15'
10'x20'



Blank Full Wall (SKU:ATBFW)

Full sidewalls can be used to provide extra protection and privacy for your events. The walls can be finished with zippers sewn at the left, right, or middle for easy access. And it can be quickly and easily attached to your tent with Velcro strips.

- **Material:**
600D PU Polyester
420D PVC Polyester
- **Lead Time:**
24H/48H
- **Size:**
10'x10'
10'x15'
10'x20'

Full Wall (Double PVC Window) (SKU:ATMPWD)

Compared to a traditional full wall which is mainly used to add extra display space or privacy, this multifunctional full wall with double windows has a new meaning of existence.

- **Material:**
Full Wall: 600D PU Polyester
Window: PVC
- **Lead Time:**
24H/48H
- **Size:**
10'x10'
10'x15'
10'x20'



Hardware-Half Wall Support Pole (SKU:ADHWSP)

The support pole is required to display tent half walls. Half Wall Support Pole spans between the tent hardware and clamps to keep the half wall graphic straight and secure.

- **Material:**
Aluminum
- **Lead Time:**
24H/48H
- **Size:**
5'x5'
10'x10'
10'x20'

Blank Canopy Tent



Compared to custom printed tents, a solid color tent with no print will be more budget-friendly, but the quality and function will not reduce.



- Available sizes: 5'x5', 6.5'x6.5', 10' x10' ,10' x15' ,10' x20', 13'x13' ,13'x20' , 13'x26' , 20'x20', Custom Sizes
- Available colors: Red, Blue, White, Black, Green, Cream Khaki
- High-quality fabrics used

BEST SELLER	QUICK SHIP	Machine Wash, Gentle	FAST COLOR	WRINKLE-FREE	SETUP VIDEO

If you don't have the logo advertising needs, but you are going to hold an outdoor activity, this solid color advertising tent would be a nice choice. It is more suitable for bulky orders for specific needs, like for charity activities or home parties and other non-profit big events. The solid color canopy tent can be neater when placed together in a row, making the activity more orderly.

- **Material:**
600D PU Polyester
420D PVC Polyester
 - **Lead Time:**
24H/48H
 - **Size:**
- | | | |
|-----------|---------|---------|
| 5'x5' | 10'x15' | 13'x20' |
| 6.5'x6.5' | 10'x20' | 13'x26' |
| 10'x10' | 13'x13' | 20'x20' |



10x10
Blank Canopy Tent(No Print) (SKU:ATBCT-10)



10x15
Blank Canopy Tent(No Print) (SKU:ATBCT-15)



10x20
Blank Canopy Tent(No Print) (SKU:ATBCT-20)



13x13
Blank Canopy Tent(No Print) (SKU:ATBCT-13x13)



13x20
Blank Canopy Tent(No Print) (SKU:ATBCT-13x20)



13x26
Blank Canopy Tent(No Print) (SKU:ATBCT-13x26)



20x20
Blank Canopy Tent(No Print) (SKU:ATBCT-20x20)

Tent Banner

Besides regular graphics like tent top, half walls, and full walls, CFM has been exploring more and more accessories & add-ons like tent leg cover, tent valance for your advertising tents.



Tent Leg High Visibility Covers (SKU:ATLHVC)

These reflective tent leg covers are a great addition to your event kit. They can be easily added to your tents for added visibility and can be used for the legs of all our tents.

- **Material:**
600D PU Polyester Fluorescent Yellow
600D PU Polyester
- **Lead Time:**
24H/48H
- **Size:**
7.9"x45.3" (20x115cm)

- Create extra advertising for your brand
- Easy to set up
- Full-color printing

Square Tent Billboard Banner (SKU:ATSTBB)

If you want additional space to extend your message and add exposure to your brand, you can consider our tent billboard banners. These banners are specially designed to match any 10ft side of our tents.

- **Material:**
180g Elastic Polyester
- **Lead Time:**
24H/48H
- **Size:**
96"x23.6" (244x60cm)



Tent Awning (SKU:ATTBTA)

Upgrade your pop up tent to a cool, comfortable and convenient canopy by adding this innovative awning. It will keep your tent cool, dry, and protected for all-day enjoyment.

- **Material:**
600D PU Polyester
- **Lead Time:**
24H/48H
- **Size:**
115.4"x35.4" (293x90cm)

Curve Tent Billboard Banner (SKU:ATCTBB)

Adding such a billboard banner with a shape like a half moon to your tent, you will get maximum brand exposure in trade shows, sports events, farmer's markets, outdoor concerts, and other promotional events.

- **Material:**
180g Elastic Polyester
- **Lead Time:**
24H/48H
- **Size:**
89.8"x41.7" (228x106cm)



Tent Valance Banner (SKU:ATTVB)

Showcase your business at your next event, trade show, or craft show with a custom tent banner. This banner is a great way to add extra display space to your existing tent.

- **Material:**
600D PU Polyester
600D PU Polyester Fluorescent Yellow
- **Lead Time:**
24H/48H
- **Size:**
5'x5' 10'x15' 13'x20'
6.5'x6.5' 10'x20' 13'x26'
10'x10' 13'x13' 20'x20'

Tent Canopy Ceiling (SKU:ATTCC)

Besides tent panels, valances, and sidewalls (half walls and full walls), the ceiling is also a space that you can utilize to make your canopy tent different.

- **Material:**
180g Elastic Polyester
- **Lead Time:**
24H/48H
- **Size:**
5'x5' 10'x15' 13'x20'
6.5'x6.5' 10'x20' 13'x26'
10'x10' 13'x13' 20'x20'



Tent Leg Cover (SKU:ATLTC)

The tent leg cover is an innovative new accessory that you can add to create a new style to your tent.

- **Material:**
600D PU Polyester
- **Lead Time:**
24H/48H
- **Size:**
60"x88" (152.4 x 223.52cm)



Tent Dust Cover (SKU:ATTDC)

This spandex, lightweight, and economical fabric cover is an accessory that you can not miss for your awnings, tents, sunshades, or canopies.

- **Material:**
180g Elastic Polyester
- **Lead Time:**
24H/48H
- **Size:**
10' X 10'
10' X 15'
10' X 20'



Tent Hardware

We provide hardware & accessories include tent frames, wheel bags, sandbag, rope & ground spike and more for advertising tents. And we have some frames and wheel bags stocked in our USA warehouses, which will help save lots of shipping cost for you.

- High-quality materials
- Easy assembly
- Budget-saving



Rope & Groundspike (SKU:ADHRG)

The heavy-duty Rope and Ground Spike Set is an excellent way to ensure your advertising tent stays firmly in place during your event.

- **Material:**
Rope: Nylon
Groundspike: Iron
- **Lead Time:**
24H/48H



Wheel Bag (SKU:ADHWB)

If you want additional space to extend your message and add exposure to your brand, you can consider our tent billboard banners. These banners are specially designed to match any 10ft side of our tents.

- **Material:**
Oxford
- **Lead Time:**
24H/48H
- **Size:**
5'X5' 10'X15' 13'X20'
10'X10' 10'X20' 13'X26'
13'X13' 20'X20'



Sandbag (SKU:ATBS/ATBH)

If you are worried about your advertising tent getting knocked down or blown over, the sand bag is recommended to you to add extra stability for your tent.

- **Material:**
Oxford
- **Lead Time:**
24H/48H
- **Type:**
Square Tent Sandbag(4)
Hex Tent Sandbag(4)



Tent Flag Mount Holder (SKU:ADFFB)

Add a flag to your event tent with this flag tent flag mount holder. We have different types to match our square and hex tent frames. And they are applicable for our Standard type advertising flags.

- **Material:**
Iron
- **Lead Time:**
24H/48H
- **Type:**
Square
Hex

Canopy Packaging Bags (No Print) (SKU:BCPB)

This packaging bag is specially introduced to offer an organized way to store your tent rooftops, tent walls, and tent accessories.

- **Material:**
600D Oxford
- **Lead Time:**
24H/48H
- **Size:**
23.6"x17.7"x7.9" (60x45x20cm)



Weight Plate (SKU:ATHWP)

Weight plates are recommended to keep your advertising tent in place. They can be used on virtually any surface, and they don't require any tools to set up.

- **Material:**
Iron
- **Lead Time:**
24H/48H











Table Covers



- 1** An easy and convenient tool to expose your brand and slogan.
- 2** An environmental friendly & recyclable way to display your products.
- 3** Various types, multiple sizes and different materials for options.

Table Covers-Standard

- 
BEST SELLER
- 
QUICK SHIP
- 
Machine Wash, Gentle
- 
FAST COLOR
- 
WRINKLE-FREE
- 
SETUP VIDEO



This classical table throw is designed to expose your promotional messages to the most. With stylish drapes and vivid printed graphics, the table throw can help you attract a lot of attentions.

- Fit for 6'(72" x 30" x 29") and 8'(96" x 30" x 29") display tables
- Dye sublimation and direct digital printing are available
- Suggested product uses: trade show, product launch, exhibition, presentation

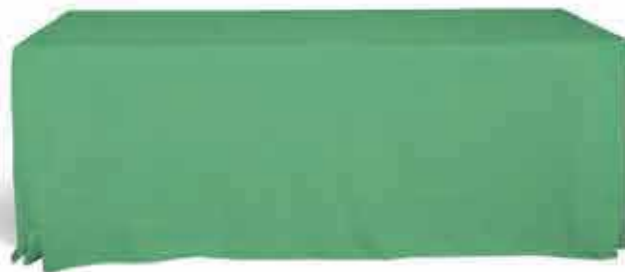

Standard Table Covers TOP SELLER
(SKU:TCTSD)



Standard Table Covers with Open Back TOP SELLER
(SKU:TCTOB)

Featuring clear and clean design, our 3-sided or 4-sided custom table throws can easily highlight your brand, logo or the important message you want to express and convey. This is our simplest type, but the most classic one that is commonly used at a trade show or an exhibition.

- Material:**
 Wrinkle-resistant 300D Polyester
 Wrinkle-resistant & Flame-retardant 300D Polyester
- Lead Time:**
 24H / 48H
- Size:**
 6FT
 8FT



Convertible Table Covers (SKU:TCTCT)

The convertible or adjustable table cover is perfect for various marketing events, exhibitions, trade shows and more. With a gorgeous convertible table covers, you will get two different promotional solutions, as our table throws can not only be converted from 8ft throw to 6ft throw but also from 8ft throw to 6ft fitted cover.

- Material:**
 Wrinkle-resistant 300D Polyester
 Wrinkle-resistant & Flame-retardant 300D Polyester
- Size:**
 6 FT
 8 FT
- Lead Time:**
 24H / 48H

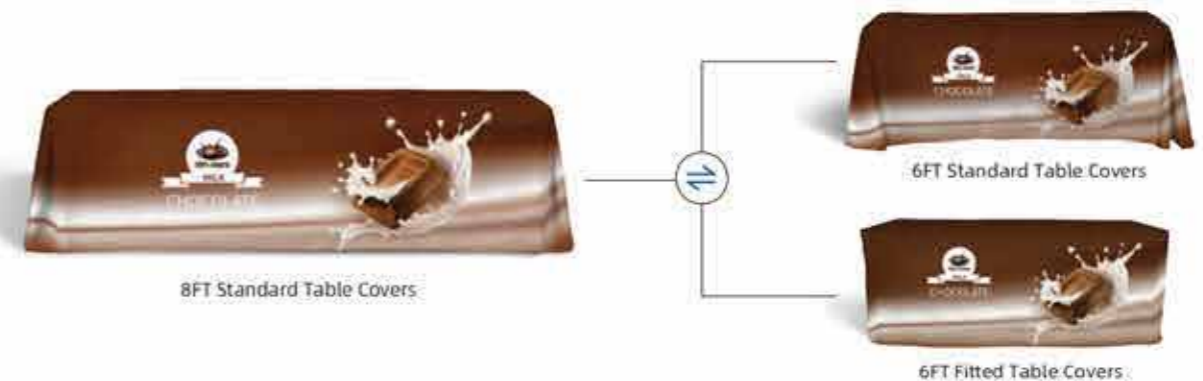
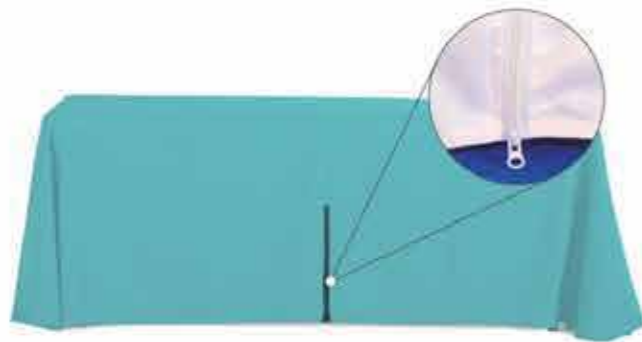

Table Covers-Fitted



Standard Table Covers with Zipper (SKU:TCTSDZ)

The custom table throw features a clear and clean design and can easily highlight your brand, logo, or the important message you want to express and convey.

- **Material:**
Wrinkle-resistant 300D Polyester
Wrinkle-resistant & Flame-retardant 300D Polyester
- **Size:**
6FT
8FT
- **Lead Time:**
24H
48H



Table Runners (SKU:TCTR)

Table runner can make a deep and strong impression on people who are "on the go". Print your logos on a table runner, your important message will reach people within minutes.

- **Material:**
Wrinkle-resistant 300D Polyester
Wrinkle-resistant & Flame-retardant 300D Polyester
- **Size:**
6FT
8FT
- **Lead Time:**
24H
48H



Round Table Covers (SKU:TCTRD)



Square Table Covers (SKU:TCTSQ)

Instead of displaying your logo and graphic by a relatively vague impression left by table throws at a long distance, such a round table for talks between 2 persons definitely offers a closer look at your logo, and thus substantially boosts your brand recognition.

- **Material:**
Wrinkle-resistant 300D Polyester
Wrinkle-resistant & Flame-retardant 300D Polyester
- **Size:**
59"x59"
- **Lead Time:**
24H / 48H



- BEST SELLER
- QUICK SHIP
- Machine Wash, Gentle
- FAST COLOR
- WRINKLE-FREE
- SETUP VIDEO

This elegantly tailored fitted table cover can perfectly cover your table. Printed with custom logos and graphics, all your marketing information can be delivered within minutes.

- Fit for 6'(72" x 30" x 29") and 8'(96" x 30" x 29") display tables
- Dye sublimation and direct digital printing are available
- Suggested product uses: trade show, product launch, exhibition, presentation



Fitted Table Covers (SKU:TCFSD)



Fitted Table Covers with Open Back (SKU:TCFOB)

As a great balance between formal and casual styles, fitted table cover is widely used by hotels, resorts, convention centers, and suitable for various environments no matter it's a professional business exhibition or a personal celebrating gathering.

- **Material:**
Wrinkle-resistant 300D Polyester
Wrinkle-resistant & Flame-retardant 300D Polyester
- **Size:**
6FT
8FT
- **Lead Time:**
24H / 48H

Table Covers-Stretch



Fitted Table Covers **TOP SELLER**
Back with Zipper (SKU:TCFBZ)

Fitted Table Covers
Back with Velcro (SKU:TCFBV)

With strong practicability and attractive look, the fitted table cover with zipper at back is a must-have for trade shows and presentations! Compared with table throws, the fitted one has a higher requirement for table size measurement and covers the table with fewer fabrics. Fitted table cover with a vertical Velcro strap along the back is specially designed, which makes it easy to open and close when you store something important underneath the table.

- **Material:**
Wrinkle-resistant 300D Polyester
Wrinkle-resistant & Flame-retardant 300D Polyester
- **Size:**
6FT
8FT
- **Lead Time:**
24H / 48H

Pleated Table Covers (SKU:TCFPT)

As a great balance between formal and casual styles, pleated table cover is widely used by hotels, resorts, convention centers, and suitable for various environments no matter it's a professional business exhibition or a personal celebrating gathering.



- **Material:**
Wrinkle-resistant 300D Polyester
Wrinkle-resistant & Flame-retardant 300D Polyester
- **Size:**
6FT
8FT
- **Lead Time:**
24H / 48H

Round Fitted Table Covers (SKU:TCFRD)

Compared with the standard custom table covers, the round fitted table cover looks much neater. More importantly, the round table cover fits very well with the size of your table.



- **Material:**
Wrinkle-resistant 300D Polyester
Wrinkle-resistant & Flame-retardant 300D Polyester
- **Size:**
24"x24"+29"x77.6"
31"x31"+29"x104"
32"x32"+43"x104"
37"x37"+29"x121"
- **Lead Time:**
24H / 48H



- BEST SELLER
- QUICK SHIP
- Machine Wash, Gentle
- FAST COLOR
- WRINKLE-FREE
- SETUP VIDEO

This snugly fitted stretch table cover can present your marketing message in an attractive way. Featuring in high elastic, it fits the table tightly and elegantly.

- Fit for 6'(72" x 30" x 29") and 8'(96" x 30" x 29") display tables
- Dye sublimation printing method is adopted
- Suggested product uses: trade show, product launch, exhibition, presentation



Stretch Table Covers **TOP SELLER**
(SKU:TCSSD)



Stretch Table Covers with Open Back **TOP SELLER**
(SKU:TCSOB)

Stretch table cover is ideal for special events, conventions, trade shows, open houses, fairs and even personal celebrations. And we have full back, open back and zipper back for your options.

- **Material:**
180g Elastic Polyester
Flame-retardant 180g Elastic Polyester
- **Size:**
6FT
8FT
- **Lead Time:**
24H / 48H

Stretch Table Covers with Zipper (SKU:TCSCR)

The fabulous spandex tablecloth features a fullback with zipper closure, aiding you in the ability to have extra storage space underneath. This product is suggested to be a better choice since you could lock your important things inside.

- **Material:**
180g Elastic Polyester
Flame-retardant 180g Elastic Polyester

- **Size:**
6FT
8FT
- **Lead Time:**
24H / 48H



Cross-over Stretch Table Covers (SKU:TCSCR)

This unique cross-over stretch table cover is ideal for various exhibitions, conventions, conferences and trade shows since it has a reversible side as the stretchy material is pulled down to cover the table legs.

- **Material:**
180g Elastic Polyester
Flame-retardant 180g Elastic Polyester

- **Size:**
6FT
8FT
- **Lead Time:**
24H / 48H



Round Stretch Table Covers (SKU:TCSR)

Made of quality elastic polyester fabrics in a broad range of colors, round stretch table covers add an attractive, professional appearance to the event tables while providing the ideal surface to promote your business with custom printing that displays your logo or advertising message to create an extra impact to your booth.

- **Material:**
180g Elastic Polyester
Flame-retardant 180g Elastic Polyester

- **Size:**
S: 24.4"x24.4"+(18.5"x27.6")x4 sides
M: 31.5"x31.5"+(23.6"x27.6")x4 sides
L: 31.5"x31.5"+(23.6"x36.2")x4 sides
XL: 36.6"x36.6"+(24.8"x27.6")x4 sides
- **Lead Time:**
24H / 48H



Square Stretch Table Topper (SKU:TCSSQ)

Table topper cover is not only a great decoration that covers a table surface that may not be so attractive but also a tool to make your presentation look clean and professional. Made of durable and stretchy fabrics, our table top covers can be used for a long time.

- **Material:**
180g Elastic Polyester
Flame-retardant 180g Elastic Polyester

- **Size:**
6FT
8FT
- **Lead Time:**
24H / 48H



Round Stretch Table Topper (SKU:TCSRT)

The round stretch table topper is a great choice to make your event table look sharp and stylish. Also, it can be used to protect your tabletop from everyday wear and tear, especially traveling back and forth to events and trade shows.

- **Material:**
180g Elastic Polyester
Flame-retardant 180g Elastic Polyester

- **Size:**
30.7"x30.7" 37.8"x37.8" 43.7"x43.7"
- **Lead Time:**
24H / 48H











Advertising Flags



- 1 Feature in lightweight, easy to assemble, set up and take away.
- 2 Custom graphics & sizes and various shapes help you get noticed.
- 3 Cost effective & budget saving display tool that creates high impact.

Advertising Flag

- 
BEST SELLER
- 
QUICK SHIP
- 
Machine Wash, Gentle
- 
FAST COLOR
- 
WRINKLE-FREE
- 
SETUP VIDEO

These displays are in various shapes and sizes. Fluttering in the air, the display flags with vivid graphic and crisp color are great to attract attentions.



- Available shapes: Concave, Convex, Straight, Angled, Teardrop, Rectangle, etc.
- Available sizes: ranging from 9ft to 16ft
- Direct digital printed 110g knitted polyester and 100D polyester

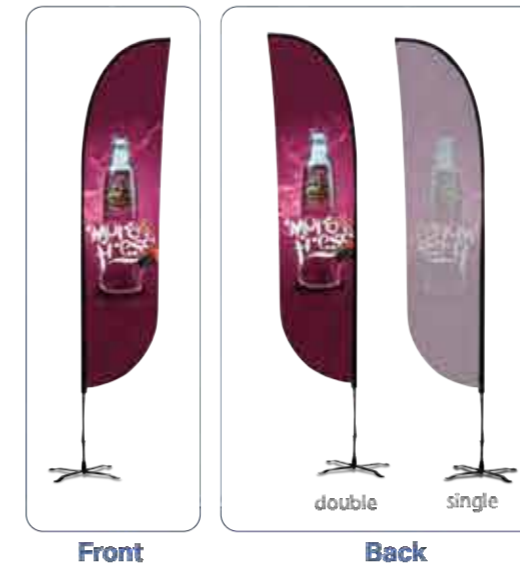
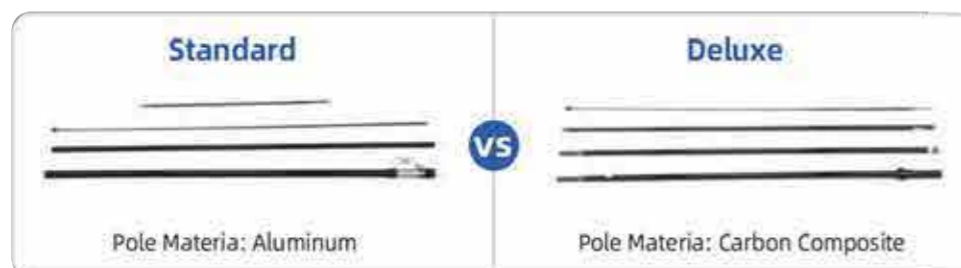

Advertising Flag (SKU:DFST / DFAG / DFCV / DFCC) -Concave/Convex/Angled/Straight

This is one of our budget-friendly advertising flags that is suitable for indoor and outdoor events and works well on busy streets, open squares and crowded trade shows.

- | | |
|---|--|
| <ul style="list-style-type: none"> ● Material:
100D Polyester
110g Knitted Polyester ● Size:
9FT 8FT
13FT 11FT
15FT 16FT | <ul style="list-style-type: none"> ● Graphic:
Single Sided / Double Sided ● Type:
Standard/Deluxe ● Lead Time:
24H/48H |
|---|--|



Advertising Flag-Teardrop (SKU:DFTD)

This is one of our budget-friendly feather flags that take the shape of the teardrop. The unique design of the teardrop flag allows your marketing information to stand out from other traditional display products.

- | | |
|---|--|
| <ul style="list-style-type: none"> ● Material:
100D Polyester
110g Knitted Polyester ● Size:
9FT 7FT
13FT 11FT
15FT 16FT | <ul style="list-style-type: none"> ● Graphic:
Single Sided / Double Sided ● Type:
Standard/Deluxe ● Lead Time:
24H/48H |
|---|--|



Advertising Flag-Rectangle (SKU:DFRT)

The affordable rectangle feather flag is widely used for indoor and outdoor events and works well busy streets, open squares and crowded trade shows.

- | | |
|--|--|
| <ul style="list-style-type: none"> ● Material:
100D Polyester
110g Knitted Polyester ● Size:
7FT 10FT
14FT 17FT | <ul style="list-style-type: none"> ● Graphic:
Single Sided / Double Sided ● Type:
Standard/Deluxe ● Lead Time:
24H/48H |
|--|--|

Duplex Printing Advertising Flag

- 
BEST SELLER
- 
QUICK SHIP
- 
 Machine Wash, Gentle
- 
FAST COLOR
- 
WRINKLE -FREE
- 
SETUP VIDEO



No matter you want a single-ply mirror image flag or a single-ply flag with 2 different artworks, our duplex printing advertising flags made of new introduced duplex printable series fabrics will help you.

- Available shapes: Concave, Convex, Straight, Angled, Teardrop, Rectangle, etc.
- Available sizes: ranging from 9ft to 16ft
- Duplex printable series fabric and new duplex printing method are adopted



Duplex Printing Advertising Flag -Concave/Convex/Angled/Straight (SKU:DPAFBD)

The fabrics used for this advertising flag are our newly introduced premium fabrics. They are single layers but can be duplex digitally printed with logos or arts on the front and backside and will not cause inter-affection.

- **Material:**
 Duplex Printable 100D Polyester (Single-Ply Flag With Mirror Image)
 Duplex Printable Blockout Polyester (Single-Ply Flag With different Images)
- **Size:**

9FT	8FT
13FT	11FT
15FT	16FT
- **Type:**
Standard/Deluxe
- **Lead Time:**
24H/48H



Duplex Printing Advertising Flag -Teardrop (SKU:DPAFTD)

This duplex printing advertising teardrop flag can easily draw attention to your booth or event due to the unique shape and exceptional print quality.

- **Material:**
 Duplex Printable 100D Polyester (Single-Ply Flag With Mirror Image)
 Duplex Printable Blockout Polyester (Single-Ply Flag With different Images)
- **Size:**

9FT	7FT
13FT	11FT
15FT	16FT
- **Type:**
Standard/Deluxe
- **Lead Time:**
24H/48H



Duplex Printing Advertising Flag -Rectangle (SKU:DPAFRT)

This is the new printing technology we adopted to make the graphic more vibrant, it can realize a 100% penetration effect and only one layer of fabric can make the flag fly more freely in the air.

- **Material:**
 Duplex Printable 100D Polyester (Single-Ply Flag With Mirror Image)
 Duplex Printable Blockout Polyester (Single-Ply Flag With different Images)
- **Size:**

7FT	10FT
14FT	17FT
- **Type:**
Standard/Deluxe
- **Lead Time:**
24H/48H

Other Flags

Advertising Flag-Shark Fin (SKU:DFSF)

This flag is designed to resemble the shape of a shark fin and can be custom printed with your logo or personalized design to give it an authentic touch.

- **Material:**
100D Polyester
110g Knitted Polyester
- **Graphic:**
Single Sided / Double Sided
- **Size:**
9FT
13FT
15FT
- **Lead Time:**
24H/48H



Spinning Dart Banner (SKU:SDB)

Spinning Dart Banner is an appealing and eye-catching display option whose uniqueness lies in its unique shape and the fact that it spins in the wind.

- **Material:**
110g Knitted Polyester
- **Graphic:**
Single Sided
- **Size:**
9FT
- **Lead Time:**
24H/48H



Advertising Flag-R Shape (SKU:DFRS)

(SKU:DFRS)

This R shape flag is one kind of advertising flags. It is not as commonly seen as other shapes like blade and teardrop, but the promoting effects will not reduce.

- **Material:**
100D Polyester
110g Knitted Polyester
- **Graphic:**
Single Sided / Double Sided
- **Size:**
9FT
- **Lead Time:**
24H/48H



Giant Flag (SKU:AFG)

Stands 5m tall, and equipped with a telescopic pole, this flag with a water base is lightweight, portable, and can provide high visibility for your message at the same time.

- **Material:**
100D Polyester
110g Knitted Polyester
- **Graphic:**
Single Sided
Double Sided
- **Size:**
17FT
- **Lead Time:**
24H/48H



Swooper Flag (SKU:AFSF)

This flags are an innovative flag type. The characteristic square tops and bottoms give them a trapezoidal appearance that make them different from most other feather flags.

- **Material:**
100D Polyester
110g Knitted Polyester
- **Graphic:**
Single Sided
Double Sided
- **Size:**
15FT
- **Lead Time:**
24H/48H

Accessories

Ground Spike (SKU:DFGS)



Cross Base (SKU:DFB)



Water Bag (SKU:DFWB)



Packing Bag (SKU:DFPB)



Custom Flags & Banners



- 1** Various shapes and sizes ensure you a splendid outdoor display.
- 2** Crisp color and exquisite designs help spread your message around.
- 3** Budget saving custom flags and banners create high visual impact.



Custom Flags and Banners



Our custom flags and banners can be used for both indoor and outdoor activities. Most of our cost-effective single sided flags and banners boast good bleeding effects while our double sided flags and banners allow you enjoy the double exposure of your logos and brands. Custom flags and banners are your top choice when it comes to add values to your brands.

- A variety of materials for options
- Custom graphics and custom sizes available
- Different materials, different printing methods

Custom Flags and Banners (SKU:CPSF/CHF/CFCB)

Enjoying custom size, graphic design, your flags/banners with logos will be attention-grabbers. Featuring gorgeous printing and creative designs, our custom flags and banners are excellent for showcasing your team spirit, company logo and helping you become the focus of the crowd.

- **Material:**
100D Polyester
110g Knitted Polyester
- **Layer:**
Single / Double
- **Size:**
2x3 3x5 3x6 4x6 5x8 6x10
Custom Size
- **Lead Time:**
24H / 48H



Duplex Printable 100D Polyester



Single-Ply Flag With Mirror Image

Duplex Printable Blockout Polyester



Single-Ply Flag With Different Images

Duplex Printing Custom Flags and Banner (SKU:DPCPSF/DPCHF/DPCFR)

If you are looking for a flag or banner that can fly freely in the air and is great for advertising in two different directions so customers can see no matter which way they are driving by your business or organization, our duplex printing flags and banners will be a perfect choice.

- **Material:** Duplex Printable 100D Polyester, Duplex Printable Blockout Polyester
- **Layer:** Single (Double-Sided Print)
- **Size:** 2x3 3x5 3x6 4x6 5x8 6x10 Custom Size
- **Lead Time:** 24H / 48H



Promotional Flags

Promotional flags are one of the cheapest forms of promotion for your business. We got dozens of different types of flags to match both indoor and outdoor displaying needs.

- **BEST SELLER**
- **QUICK SHIP**
- **Machine Wash, Gentle**
- **FAST COLOR**
- **SETUP VIDEO**

- Budget-friendly
- Full-color printing
- Free artwork service



Golf Flags (SKU:CFPPGF-1)

Golf course flags are used for golf courses all over the world. Having personalized golf hole flags with your course's name and logo at each tee box and station is a great way to reinforce your course's branding.

- **Material:** 110g Knitted Polyester, 100D Polyester
- **Lead Time:** 24H / 48H
- **Size:** 37x50.8cm, Custom Size
- **Layer:** Single / Double

Garden Flags (SKU:CFPPGF)

The customized garden flag with your logo on it means much more than just an embellishment, but acts as a symbol, or a sign which delivers your messages to passersby.

- **Material:** 110g Knitted Polyester
- **Layer:** Single / Double
- **Size:** 30x45.7cm, 33x45.7cm, Custom Size
- **Lead Time:** 24H / 48H

Backpack Flags (SKU:CFPFBF)

Whether you're looking to advertise for a new opening or prepare for sales at a fair or event, this Backpack Flag will make you and your business outstanding in the crowd. It is ideal for promoting events and campaigns, your booth at an exhibition or keeping your tour group together.

- **Material:**
110g Knitted Polyester
- **Layer:**
Single / Double
- **Size:**
Blade: 51x122cm/ 44.5x103.5cm
Teardrop: 52x103cm/42x82cm
Rectangle: 42.5x80cm
U Shaped: 50.5x105.5cm
- **Lead Time:**
24H / 48H



Table Feather Flags (SKU:CFPTFF)

As the mini version of our Display Flag, table display flag is a good choice for you if you want to decorate your site no matter in a formal or informal occasion. This mini display is an eye-catching display which is often used next to a new product or when drawing attention to things like take out menus.

- **Material:**
110g Knitted Polyester
- **Layer:**
Single / Double
- **Size:**
Straight:14x45cm
Teardrop:21.8x38.1cm
- **Lead Time:**
24H / 48H



Podium Flags (SKU:CFPPFF)

Leave a deep impression on the audience with podium flags. Made from attractive yet durable polyester satin and available in many sizes, besides, they are portable and easy to use. They are also wonderful for permanent use as lectern banners in churches and educational environments.

- **Material:**
Satin
- **Layer:**
Single / Double
- **Size:**
15.2x20.3cm
20.3x30.5cm
30.5x45.7cm
Custom Size
- **Lead Time:**
24H / 48H



Car Flags (SKU:CFPFCF)

Car flag is a fashionable way to display your logos and brands. No matter you are driving the car or you just stop at a parking lot, with a promotional car flag installed on your car, you can grasp people's curiosity and attention instantly.

- **Material:**
110g Knitted Polyester
- **Size:**
30.5x45.7cm
Custom Size
- **Layer:**
Single
Double
- **Lead Time:**
24H / 48H



Suction Cup Flag (SKU:CFSCF)

These small suction cup flags are great for use by cash registers, at the front desk, on your storefront window, or even as a great giveaway! They can be adhered without damage to clean glass, metal, or tile surfaces easily.

- **Material:**
110g Knitted Polyester
- **Size:**
Blade:28.44x67.6cm
Teardrop: 28.4x56.6cm
Rectangle:22.9x52cm
- **Layer:**
Single
Double
- **Lead Time:**
24H / 48H



Street Banners (SKU:CF5B)

Custom street banner, also called pole banner, light pole banner bracket, or street light banner, would usually be displayed high on building or street pole, which can be seen from a distance, therefore, it would definitely be an ideal way to highlight your marketing.

- **Material:**
110g Knitted Polyester
- **Size:**
Custom Size
- **Layer:**
Single
Double
- **Lead Time:**
24H / 48H

Spare Tire Cover (SKU:CFSTC)

Simply add your own design to this cover for your spare tire, it can not only show people what you're passionate about, it can also be used as a billboard to promote your business.

- **Material:**
600D PU Polyester
- **Size:(Diameter)**
66cm 69.9cm
71.1cm 74.4cm
75cm 81.3cm
88.9cm
- **Layer:**
Single
- **Lead Time:**
24H / 48H



Car Mirror Cover (SKU:CFCMC)

This car mirror cover is great for decorating your car, or you can just cover them on your side mirrors for protection. And as custom logos and designs are accepted, they are also an ideal tool to show your pride in your country, your hometown, or your favorite sports.

- **Material:**
180g Elastic Polyester
- **Layer:**
Single
- **Size:**
Sedan: 27x24cm
SUV: 30x24cm
- **Lead Time:**
24H / 48H



Hanging Wooden Poles Banner (SKU:CFHWPB)

Ensure your business gets plenty of attention with this large hanging banner flag. They can be easily hung anywhere both indoors and outdoors to increase the exposure of your brand and to drive traffic into your business.

- **Material:**
Duplex Printable Blockout Polyester
- **Layer:**
Single (Double-Sided Print)
- **Size:**
Custom Size
- **Lead Time:**
24H / 48H



Car Window Flag (SKU:CFFWF)

Car Window Flag is a perfect mobile advertising solution to boost your business. It will draw extra attention to you at any event. Our car window flags are great for all vehicles. Each custom car window flag can be made to fit your graphics and scenarios.

- **Material:**
110g Knitted Polyester
- **Layer:**
Single / Double
- **Size:**
Blade: 28.5x67.5cm
Teardrop: 28.4x56.6cm
Rectangle: 23x52cm
- **Lead Time:**
24H / 48H



Desk Flag (SKU:CFDFSF)

The custom desk flag is great decorations for offices, families, conference rooms, etc. Meanwhile, it is also an affordable and effective promoting tool for its' small yet great display effects.

- **Material:**
110g Knitted Polyester
- **Size:**
Single Flag 14x21cm
Double Flags 14x21cm
- **Layer:**
Single
Double
- **Lead Time:**
24H / 48H



Custom Breakaway Banners (SKU:CFCBB)

Custom make a breakthrough banner to fire your team and fans up with a grand entrance! A break through banner printed with your logo or slogan is a perfect choice for your next sports event to keep the players in utmost enthusiasm and team spirit.

- **Material:**
110g Knitted Polyester
- **Size:**
Custom Size
- **Layer:**
Single
- **Lead Time:**
24H / 48H



Body Flags (SKU:CFPFBF-2)

Body flags, also called cape flags, is a kind of novel flag that might not be known by many people. It is good for decoration, celebration, advertising, and promotion. With 2 sleeves designed, it can be worn at sporting events, festivals, and more.

- **Material:**
110g Knitted Polyester
- **Size:**
91.4x152.4cm
- **Layer:**
Single
- **Lead Time:**
24H / 48H



Bollard Cover (SKU:CFBC)

These custom printed bollard covers allow you to creatively advertise on previously untapped spaces like protective posts that guard gas pumps, storefronts, food restaurants, banks, and any other bollard location.

- **Material:**
Flame-retardant 180g Elastic Polyester
- **Size:**
Custom Size
- **Layer:**
Single
- **Lead Time:**
24H / 48H

Car Headrest Covers (SKU:CFCHC)

These headrest covers will fit most standard headrests on most vehicle's seats with the high-quality stretchy fabrics used. The pattern and designs are up to you. You can add more interesting or personalized elements to your car with these covers.

Material:	Size:	Layer:	Lead Time:
180g Elastic Polyester	22.9x25.4cm 26.7x41.1cm 30.5x45.7cm	Single	24H / 48H



Clip Flags (SKU:CFPCF-1)

Clip flags, or clip-on flags, have become quite popular among business owners who want to increase the visibility of their messages in an affordable and easy way. They are suitable for various promotional activities, press conferences, sales promotion and celebrating events as they can be attached to any point you want with a clip.

Material:	Size:	Layer:	Lead Time:
110g Knitted Polyester	Blade:28.4x65.6cm Teardrop: 28.4x56.6cm Rectangle:22.9x52.1cm	Single Double	24H / 48H



Hand Flags (SKU:CFHF)

Hand flag, also called hand waving flag, is great for events like rallies, parades, or marches. With your logo or brand info printed on it, this small and economical flag can help deliver your message well in the crowd.

Material:	Size:	Layer:	Lead Time:
110g Knitted Polyester	10.2x15.2cm 15.2x22.9cm 20.3x30.5cm 30.5x45.7cm 61x91.4cm	Single Double	24H / 48H



Windsock Flag (SKU:CFWF)

Originally, windsocks are used to determine the direction and the speed of the wind at airports and other locations where required. And now it has gradually been converted to effective marketing tool and decorative product.

Material:	Size:	Layer:	Lead Time:
110g Knitted Polyester	Custom Size	Single	24H / 48H



Magnetic Car Flags (SKU:CFPMC)

Just as regular car flags, these flags are also a chic and sufficient way to display your logos or brands. It is suitable for any kind of vehicle. Whenever you have an auto show or promotional campaign, these small magnetic car flags are a good choice for you.

Material:	Size:	Layer:	Lead Time:
110g Knitted Polyester	21x14cm	Single / Double	24H / 48H



Car Antenna Flags (SKU:CFCAF)

These antenna flags are a great way to add a little extra marketing to your car when you are driving. You can add any logo or images you like on them. It is a great way to express your adoration to your country, your veterans and your favourite sports team.

Material:	Size:	Layer:	Lead Time:
110g Knitted Polyester	10.2x15.2cm 20.3x30.5cm	Single Double	24H / 48H



Felt Pennants (SKU:CFPPF)

Felt pennants became popular mainly due to the proliferation of colleges and universities, and the popularity of a new sport called football. So they are most commonly used by schools and sports teams to show their pride.

Material:	Size:	Layer:	Lead Time:
280g Felt	Custom Size	Single	24H / 48H

Bike Flags (SKU:CFBF)

Initially designed for bicycle safety, these flags have also become popular for marketing purposes. They are great mobile advertising tool. Print your logo on the flag, and set up on the bike, when you are cycling, it will create an eye-catching look when moving or stationary to help spread your brand and products.

Material:	Size:	Layer:	Lead Time:
110g Knitted Polyester	30x20cm Custom Size	Single / Double	24H / 48H



Vimbo Displays



- 1 A novel and innovative way to grab attentions from potential customers.
- 2 A lightweight and portable tool used for indoor and outdoor displays.
- 3 Appealing shapes & multiple sizes are available for you to choose from.



Tension Fabric Displays

A tension fabric display with unique graphic is noticeable among the crowd. The prominent printing space can always present you with an eye-popping and breath-taking image, which also allows you to enjoy the largest brand exposure.

- 2 shapes, 3 standard sizes, and custom size available
- High resolution dye-sublimation printing
- Large display space, perfect for expansive images and messages

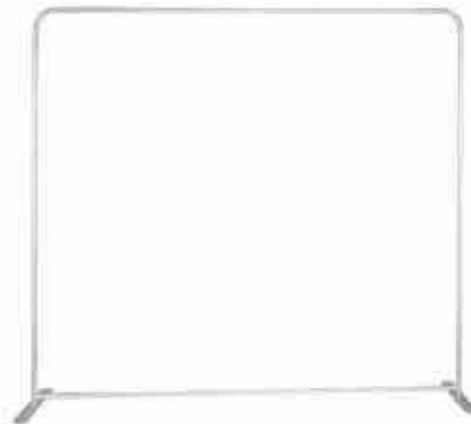

Straight Tension Fabric Display (SKU:BDTFD-ST)

Prominent printing space allows you to enjoy the largest brand exposure. The tension fabric tube display with the unique graphic is noticeable among the crowd.

- **Material:** 240g Tension Fabric
- **Size:** 8ft (245x228cm), 10ft (292.2x228cm), 20ft (596x228cm)
- **Layer:** 2 Layers Single Sided, 2 Layers Double Sided
- **Lead Time:** 24H / 48H

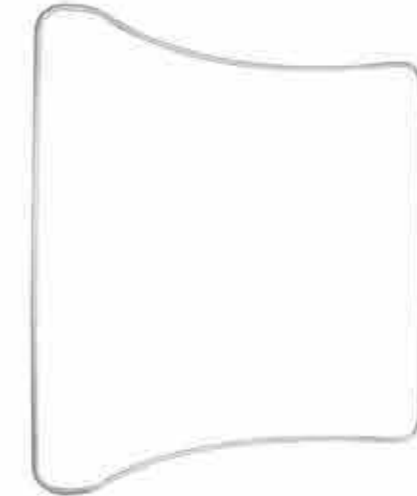

Curved Tension Fabric Display (SKU:BDTFD-CV)

Tailed with grand size and unique shape, the curved tension fabric display can always present you with an eye-popping and breath-taking image, which can be immediately become the focus in the crowd.

- **Material:** 240g Tension Fabric
- **Size:** 8ft (264x228cm), 10ft (317x228cm), 20ft (656x228cm)
- **Layer:** 2 Layers Single Sided, 2 Layers Double Sided
- **Lead Time:** 24H / 48H

Step and Repeat Backdrop

(SKU:VDSRB)

Step and repeat backdrops are often seen at red carpets events and other important occasions like movie premieres, PR events, birthday parties, press conferences, media campaigns and products launch.

- Custom size graphics available
- With adjustable frame to fit any space
- Full-color digital printing creates a stunning, vivid image

- **Material:** 110g Knitted Polyester
- **Size:** Custom Size
- **Lead Time:** 24H / 48H





EZ Tube Banner Stands



Fabric banner stands are firm and sturdy that can be freely standing in any place in your show room, in a lobby, or open space. They are great for grabbing attention at exhibitions and events and can also be used for displays in showrooms and retail environments too.

- Various types optional
- Light weight and easy to assemble, no extra tool required
- Wrinkle resistant fabric for long-last use and perfect display effect

X Banner (SKU:VDXB)

X banner is an extremely lightweight tension banner. It can be assembled easily in minutes with its strong plastic X frame. It's an ideal selection for you in the reception area or showroom.

- **Material:**
600D Tarpaulin
- **Lead Time:**
24H / 48H
- **Size:**
2FT (60x160cm)
2.6FT (80x180cm)



Fabric Banner Stand-Premium (SKU:8DFBS-P)

Faunt your brand with premium retractable banner stands made of high-quality materials. This custom banner stand is the deluxe retractable banner. Its high-quality aluminum base and pole structures hold our durable banners in place.

- **Material:**
240g Tension Fabric
- **Layer:**
2 Layers Single Sided
2 Layers Double Sided
- **Lead Time:**
24H / 48H
- **Size:**
2FT (61.2x228cm)
2.5FT (76.2x228cm)
2.6FT (80.0x228cm)
2.8FT (85.0x228cm)
3FT (91.7x228cm)
4FT (122.2x228cm)
5FT (152.6x228cm)
- **Details:**



Fabric Banner Stand- Standard (SKU:8DFBS-S)

This standard economy banner stand is economical, effective, and perfect for any setting. It features a lightweight design and a fitting amount of display for high-resolution graphics that will be printed on the fabric using dye sublimation.

- **Material:**
240g Tension Fabric
- **Layer:**
2 Layers Single Sided
2 Layers Double Sided
- **Lead Time:**
24H / 48H
- **Size:**
2FT (61.2x228cm)
2.5FT (76.2x228cm)
2.6FT (80.0x228cm)
2.8FT (85.0x228cm)
3FT (91.7x228cm)
4FT (122.2x228cm)
5FT (152.6x228cm)
- **Details:**



L Banner (SKU:VDLB)

This classic, simple, and cost-effective L-shaped banner stand is perfect for exhibition, trade show, or any marketing events to put your brand and display at the center of attention.

- **Material:** Silver Coated Satin
- **Lead Time:** 24H / 48H
- **Size:** 2.6FT (80x200cm)



Rollup Banner (SKU:VDRP)

Rollup is one of the most convenient ways and most commonly used display tools among all the promotional products. It is excellent for communicating messages or marketing brands.

- **Material:** 600D Tarpaulin
- **Lead Time:** 24H / 48H
- **Size:** 2.6FT (80x200cm)
2.8FT (85x200cm)



S Shape Fabric Banner Stand (SKU:BDSSF8S)

Fabric banner stand, also known as Tension Fabric Display, Stretch Fabric Tube System, Z Tube Display, EZ Tube Stand, is great for trade shows, exhibitions, and different kinds of promotional events.

- **Material:** 240g Tension Fabric
- **Lead Time:** 24H / 48H
- **Size:** 36.2"x91.3" (92x232cm)



Fabric Display Stand (SKU:VDFDS)

This fabric display stand tower features 3D shape that can be viewed from all sides. It is a perfect way to enhance your trade show exhibit while presenting your brand as it is compact, lightweight, and easy to set up.

- **Material:** 240g Tension Fabric
- **Lead Time:** 24H / 48H
- **Size:** 35.4"x82.7" (90x210cm)



L Banner Backwall (SKU:VDLBB)

Grab the attention your brand deserves at a high-traffic event with this lightweight and highly portable L banner back wall. It is great for the red carpet, media events, photoshoots, or trade shows - providing a high-quality finish at an amazing price!

- **Material:** 250g Soft Knitted Polyester
- **Lead Time:** 24H / 48H
- **Size:** 10FT (300x230cm)
20FT (600x230cm)

EZ Extend Circle Backdrop (SKU:VDEECB)

EZ extend circle backdrop is a custom printed backdrop that is ideal for use at trade shows, expos, conventions, grand events, and more. As a great way to show off your business and brand, this custom-printed backdrop is sure to benefit any company.

- **Material:** 240g Tension Fabric
- **Lead Time:** 24H / 48H
- **Size:** 5FT Diameter:(150cm)
6.5FT Diameter:(200cm)



EZ Extend Heart Shaped Backdrop (SKU:VDEEHSB)

Whether you're looking for a unique backdrop for a special event like a wedding, bridal party, anniversaries, trade shows, exhibitions, or something to add color to your decor, this heart-shaped backdrop will add an elegant and distinctive touch to any room.

- **Material:** 240g Tension Fabric
- **Lead Time:** 24H / 48H
- **Size:** 200x195cm



EZ Extend Moon Shaped Backdrop (SKU:VDMMSB)

Don't settle for a plain backdrop at your next event. Upgrade to our Portable Crescent Moon Shaped Backdrop and create a stunning, memorable experience for your guests.

- **Material:** 240g Tension Fabric
- **Lead Time:** 24H / 48H
- **Size:** 200x195cm



EZ Tube Modular Display Kit A (SKU:VDETMDA)

This EZ Tube Modular Display Kit is the perfect solution for displaying information in a modern, attractive, and economical way. It can be used for product promotion and as an advertising display in trade shows, shopping malls, department stores, garment factories, and other industries.

- **Material:** 240g Tension Fabric
- **Lead Time:** 24H / 48H
- **Size:** Section 1 (91.4x183cm)
Section 2 (122x213cm)
Section 3 (91.4x183cm)



EZ Tube Modular Display Kit B (SKU:VDETMDB)

Compared to a traditional trade show modular display, this innovative EZ tube modular display kit provides a more convenient and cost-effective display solution. It is lightweight, highly portable, and super easy to assemble, you can set it up just by yourself with no extra tools!

- **Material:** 240g Tension Fabric
- **Lead Time:** 24H / 48H
- **Size:** Section 1 (91.4x183cm)
Section 2 (122x213cm)
Section 3 (91.4x122cm)

Display Counters

- 👍 BEST SELLER
- 🚚 QUICK SHIP
- 💧 Machine Wash, Gentle
- 🔄 FAST COLOR
- 🎥 SETUP VIDEO

Display counters, also called popup booths, pair well with any back walls, backlit displays and table-top display and can be combined with other trade show accessories to add style and valuable space for your display booth.

- Cost-effective & Easy to set up and transport
- Add style and valuable space for product placement
- Excellent, affordable addition to any exhibitor booth space



Spring Up Display Counter (SKU:VDSUDC)

This innovative oval-shaped display counter is an amazing solution for your trade shows, conferences, conventions, and exhibition needs. Just as its name indicates, with the spring mechanism, it can be pulled up or retracted within seconds! With a flat top and fully customizable graphic, it can be used as a podium, a table, or a product display shelf.

- **Material:** 240g Tension Fabric
- **Size:** 165x101cm
- **Lead Time:** 24H / 48H



Spring Up Display Counter With Led Lights (SKU:VDSUDCLL)

This is an upgraded product of our Spring Up Display Counter. In addition to being able to pull up and lay down within 5 seconds, it's also equipped with bright white LED lights inside that will draw more attention to your booth!

● Material:	● Size:	● Lead Time:
260g Backlit Fabric	178x101cm	24H / 48H



Deluxe Oval Popup Booth (SKU:VDDOPB)

Such a custom-printed fabric pop up booth is a perfect display tool that will set your display or exhibition apart from the competition with the excellent demonstration surface. And with the flat top, it can also be served as a product display shelf or used as a rostrum.

● Material:	● Size:	● Lead Time:
240g Tension Fabric	148x99cm	24H / 48H



Deluxe Square Popup Booth (SKU:VDDSPB)

Such a custom-printed fabric pop up booth is a perfect display tool that will set your display or exhibition apart from the competition with the excellent demonstration surface. And with the flat top, it can also be served as a product display shelf or used as a rostrum.

● Material:	● Size:	● Lead Time:
240g Tension Fabric	210x99cm	24H / 48H



Deluxe Triangle Popup Booth (SKU:VDDTPB)

Practical, functional and portable, a Pop Up Booth will make your display easy but efficient still in brand promoting. The unique outlooks with vivid and crisp graphic make it ideal for trade shows, exhibitions, presentations, product demos or retail displays.

● Material:	● Size:	● Lead Time:
240g Tension Fabric	188.5x103cm	24H / 48H



Folding Fabric Display Counter (SKU:VDFFDG)

This vibrant folding rectangular fabric display podium is a popular choice with its versatility and easy setup procedures. It is ideal for any trade show, traveling exhibit, in-store display, and other promotional events.

● Material:	● Size:	● Lead Time:
240g Tension Fabric	464x103cm	24H / 48H



Fabric Pop Up Counter Display (SKU:VDFPUCD)

A portable and lightweight way to market your products, this Fabric Pop Up Counter Display is a great way to quickly raise brand awareness for your brand. The compact design makes it easy to carry around and set up anywhere.

● Material:	● Size:	● Lead Time:
240g Tension Fabric	173x100cm	24H / 48H



Display Counter Kit (SKU:VDDCK)

This display counter kit is a great addition to your trade show exhibit display. It is a unique and flexible display system that can help you stand out from the competition at your next trade show or event.

● Material:	● Size:	● Lead Time:
240g Tension Fabric	Section 1 (33x60cm) Section 2 (36x75cm) Section 3 (40x90cm)	24H / 48H



Fabric Popup Displays

- 
BEST SELLER
- 
QUICK SHIP
- 
Machine Wash, Gentle
- 
FAST COLOR
- 
SETUP VIDEO

Pop Up display is a quick and easy way to get maximum exhibition backdrop coverage in a small budget. It is an excellent marketing tool no matter at trade shows, in-store events or exhibitions, and is also great for press conferences, media events, fundraisers, special events and even weddings.

- Generous graphic space for maximum impact
- With quality aluminium frame, durable and sturdy
- Special whole frame design, easy to set up and put away



Curved Fabric Popup Displays (SKU:VDFPD-CV)

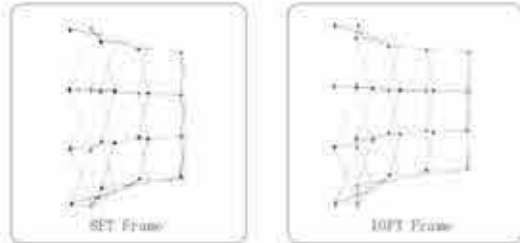

The curved fabric popup stand is a kind of innovative display tool that can deliver your message in a stylish way. Ideal for use at trade shows, exhibitions or retail backdrops, the fabric popup stand is simple to assemble with a custom printed fabric graphic.

- Material:**
240g Tension Fabric
- Size:**
8FT (228x228cm)
10FT (349x228cm)
- Lead Time:**
24H / 48H

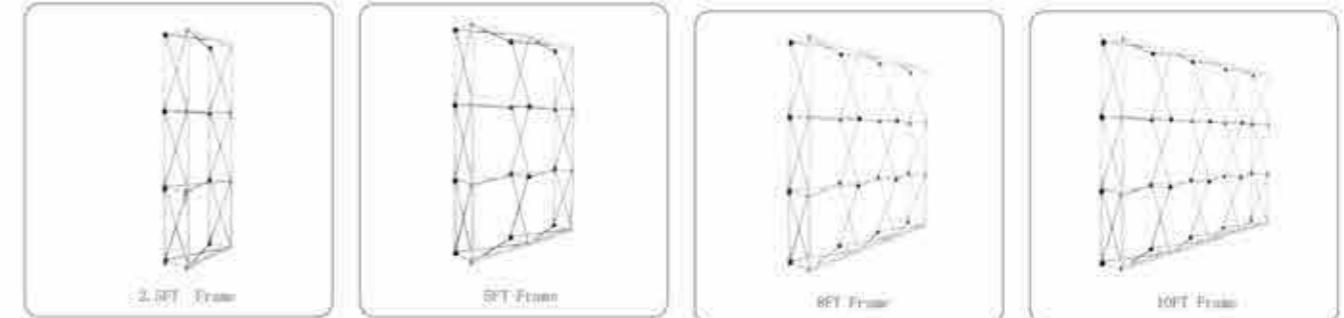

Straight Fabric Popup Displays (SKU:VDFPD-ST)

Featuring outstanding print size and novel design, this straight fabric popup stand is often used as a display wall or background wall. No matter setting it up inside a shopping mall, in front of your shop, or at a display trade show, it will attract instant attention from the passers-by.

- Material:**
240g Tension Fabric
- Lead Time:**
24H / 48H

- Size:**
2.5FT (142x230cm)
5FT (220x228cm)
8FT (298x228cm)
10FT (373x228cm)



Floor Grid Pop Up Display

The perfect tool for displaying customized graphics in a modern, fresh and stylish way.

● **Material:**
Flame-retardant 240g Elastic Polyester

● **Lead Time:**
24H / 48H



Triangular Large Floor Grid Pop Up Display
(SKU:PPGPUP-TL)



Triangular Middle Floor Grid Pop Up Display
(SKU:PPGPUP-TM)



Triangular Small Floor Grid Pop Up Display
(SKU:PPGPUP-TS)



Double X Floor Grid Pop Up Display
(SKU:PPGPUP-DX)



X Floor Grid Pop Up Display
(SKU:PPGPUP-X)



1x3 Floor Grid Pop Up Display
(SKU:PPGPUP-1X3)



3x3 Floor Grid Pop Up Display
(SKU:PPGPUP-3X3)



2x3 Floor Grid Pop Up Display
(SKU:PPGPUP-2X3)



2x2 Floor Grid Pop Up Display
(SKU:PPGPUP-2X2)

Table Top Displays

Clean and compact, these mini-size display stands are perfect for optimizing space. They can be placed on table top or desktop to present your product message in a high impact format.

- Space-saving
- Highly portable and lightweight
- Easy to set up



Table Top Banners (SKU:VDTTB)

The Table Top Banner is available in 6' and 8' options with a custom printed overt-the-table banner display. Your logo and graphics will be printed on our selected fabrics in vibrant color. With such a banner, your display will stand out in minutes even in a crowded environment.

● **Material:**
180g Elastic Polyester

● **Lead Time:**
24H / 48H

● **Size:**
S: 6FT(40x176cm)
M: 6FT(100x176cm)
L: 6FT(155x176cm)
S: 8FT (40x236cm)
M: 8FT (100x236cm)
L: 8FT (155x236cm)

● **Layer:**
2 Layers Single Sided
2 Layers Double Sided



Carbon composite poles easily slide onto clamps



Mini Rollup (SKU:VDMR)

The mini roll up is a great way to promote your event or business while saving space. It can be placed on table top or desktop to present your product message in a high impact format. It is commonly used for advertising and marketing at exhibitions, conferences, seminars or in-store promotions.

● **Material:**
Silver Coated Satin

● **Size:**
(A3)29.7x42cm
(A4)21x29.7cm

● **Lead Time:**
24H / 48H

Grid Table Top Pop Up Display

Turn your trade show booth display into a confident introduction to your business.

- **Material:**
Flame-retardant 240g Elastic Polyester
- **Lead Time:**
24H / 48H



**Triangular Large
Grid Table Top Pop Up Display**
(SKU:GTPUD-TL)



**Triangular Middle
Grid Table Top Pop Up Display**
(SKU:GTPUD-TM)



**Triangular Small
Grid Table Top Pop Up Display**
(SKU:GTPUD-TS)



**Double X
Grid Table Top Pop Up Display**
(SKU:GTPUD-DX)



**X
Grid Table Top Pop Up Display**
(SKU:GTPUD-X)



**1x3
Grid Table Top Pop Up Display**
(SKU:GTPUD-1X3)



**3x3
Grid Table Top Pop Up Display**
(SKU:GTPUD-3X3)



**2x3
Grid Table Top Pop Up Display**
(SKU:GTPUD-2X3)



**2x2
Grid Table Top Pop Up Display**
(SKU:GTPUD-2X2)

Table Top Banner-Side Panel (SKU:TTBSP)

This side panel (wing panel) is a complemented accessory of our Table Top Banner. It can be easily attached to the tabletop banner frame to help create enormous amounts of ad space for your business.

- **Material:**
180g Elastic Polyester
- **Size:**
144x40.5cm
- **Lead Time:**
24H / 48H



5ft Table Top Fabric Popup Displays (SKU:VDTTFPD)

Need a simple and stylish solution to display your products in a professional and realized manner? Take a look at this table top fabric popup display. It is a sleek, collapsible, portable tabletop display that delivers style with minimal effort.

- **Material:**
240g Tension Fabric
- **Size:**
153.5x222cm
- **Lead Time:**
24H / 48H



Monopode Flag Display Kit (SKU:VDMFDK)

Whether for events such as trade shows and conventions or as in-store or sidewalk displays, this stylish flag display kit can effectively broadcast your brand messaging. It is an excellent marketing tool that is easy to set up and looks professional.

- **Material:**
110g Knitted Polyester
- **Size:**
S (28x50cm)
L (28x100cm)
- **Lead Time:**
24H / 48H

Tabletop Tension Fabric Display (SKU:VDTTFD)

Clean and compact, beautifully self-standing, and slightly curved, this mini-size tension fabric display stand is a perfect portable backdrop for optimizing space. It is a very effective way to get your message across at any convention.

- **Material:**
240g Tension Fabric
- **Size:**
83x51cm
- **Lead Time:**
24H / 48H





Patio & Marketing Umbrellas

A custom printed umbrella with your logo and brand information will make it a great tool to attract your targeted customers while providing shade and shelter for you from the sun and rain.

- Weather resistant umbrella canopy
- Sturdy 8-rib construction
- Strong aluminum alloy frame



2x2m Square Patio Umbrellas With Valances (SKU:VDCPUWV)

Patio umbrellas are widely used for recreation, outdoor decorations, and brand builder. They are ideal for creating shade for outdoor eating areas at bars, cafes, restaurants, and more.

Material:	Size:	Lead Time:
600D PU Polyester	200x200cm	48H / 72H

2x2m Square Patio Umbrellas (SKU:VDSPU)

Although enjoying the sunshine is one of the most wonderful things in our life, sometimes you will also need some shade while relaxing or having some outdoor activities. You can cool off your porch, patio, or garden with this patio umbrella.

Material:	Size:	Lead Time:
600D PU Polyester	200x200cm	48H / 72H



2.7x2.7m Tilting Patio Umbrellas (SKU:VDTPU)

Designed with tilt crank, our tilting patio umbrella is ideal for both residential and commercial areas, such as garden, pool, deck, porch, yard, lawn, backyard, balcony, restaurant, and any other outdoor areas.

Material:	Size:	Lead Time:
600D PU Polyester	270x270cm	48H / 72H



3x3m Round Market Umbrellas With Valances (SKU:VDRMUWV)

Custom market umbrellas are perfect for any commercial application such as cafes, restaurants, or outdoor events. They can be custom printed with your logo, company name, or other marketing information to help promote your business while providing shade and shelter for you from the sun and rain.

Material:	Size:	Lead Time:
600D PU Polyester	300x300cm	48H / 72H



3x3m Round Market Umbrellas (SKU:VDRMU)

This classic round market umbrella is a perfect addition to add shade to your patio, garden, veranda, or deck space. It is also perfect for creating an outdoor seating space at restaurants or bars. The large 3x3m canopy will provide plenty of shade from the sun or cover from the rain.

Material:	Size:	Lead Time:
600D PU Polyester	300x300cm	48H / 72H



3x3m Square Market Umbrellas (SKU:VDSMU)

These square market umbrellas are brilliant promotional items for hotels, travel agencies, and holiday & restaurant businesses to provide shade and shelter for their customers while making a solid brand image.

Material:	Size:	Lead Time:
600D PU Polyester	300x300cm	48H / 72H

3x3m Square Market Umbrellas With Valances (SKU:VDSMUWV)

Our market umbrellas will give your maximum brand presence with the 3x3m custom printed roof panels and valances. They are perfect for restaurants, cafes and shops looking for a stylish and contemporary look, and are also ideal for events, markets, shows, wineries and all outdoor promotional activities.

Material:	Size:	Lead Time:
600D PU Polyester	300x300cm	48H / 72H



Barricade Covers

- 
BEST
SELLER
- 
QUICK
SHIP
- 
Machine Wash,
Gentle
- 
FAST
COLOR
- 
SETUP
VIDEO

A barricade works well in crowd controlling in grand openings, sporting events, festivals, parades, and other high-traffic areas. It can also be used as a powerful and effective marketing tool with a vivid graphic printed with your logo and brand information.

- Quick setup and removal
- Full-color printing
- Not only advertise your brand and products but also help separate the crowd

A-Frame Banner Stand (SKU:VDAFBS)

No matter you are planing a fair, a sidewalk sale, a church picnics or a trade show, this easy set-up A frame banner is a perfect choice for you to attract attention for your brand. You can also use it to direct your guests to a wedding or family reunion. And it is also commonly used at sporting events.

- **Material:**
600D Tarpaulin
- **Size:**
2.6FT (80x200cm)
- **Lead Time:**
24H / 48H



Barricade Cover (SKU:VDDBC)

Crowd control barricades work well in maintaining safe social distancing between people. With a custom barricade cover, you can easily turn them into an extra marketing space with high visibility for your brand among crowds.

- **Material:**
240g Tension Fabric
- **Size:**
3.3FT (90x100cm)
6.5FT (90x200cm)
- **Lead Time:**
24H / 48H



Custom Barricade Jackets
(SKU:VDCBJ)



Our barricade with a jacket is not only an effective way to boost your business or products, it also provides an affordable and practical way to define areas or direct traffic flow. It can effectively help people maintain safe social distancing in public places.

- **Material:**
600D Tarpaulin
- **Size:**
6.5FT (84x184cm)
- **Lead Time:**
24H / 48H

Custom Crowd Barrier Cover (SKU:VDCCBC)



If you are going to take part in a big trade show and there will be so many people at the event. You may need crowd barriers to protect your potential customer from being crowded away. Under such a situation, you can customize a barrier cover with your logo to get more exposure for your brand.

- **Material:**
600D Tarpaulin
- **Size:**
Custom Size
- **Lead Time:**
24H / 48H

Other Displays



CFM provides other dozens of display products to help boost your business to next level. And more products will be included, just stay tuned.



Racing Air Gate (SKU:VDRAG)

This arch shape race gate is mainly used for building FPV air race track. It is a perfect choice for FPV race organizers, clubs, and anyone who wants to test and improve their FPV flying skills.

- **Material:**
110g Knitted Polyester
- **Size:**
S:199x107cm
M:279x148cm
L:372.6x193.5cm
- **Lead Time:**
24H / 48H



SEG Banner (SKU:VDSEGB)

If you get tired of displaying your brand and logo by advertising tent and flags, you can try this new type of promotional product, silicone edge graphic sign. It can better present your brand logo in a plain graphic without wrinkles. You can hang it in a conspicuous place to get more attention from your customers. The fresh color and exquisite printing can improve the promotional effect of your event.

- **Material:**
240g Tension Fabric
- **Size:**
S:60x60cm
M:60x90cm
L:70x100cm
- **Lead Time:**
24H / 48H

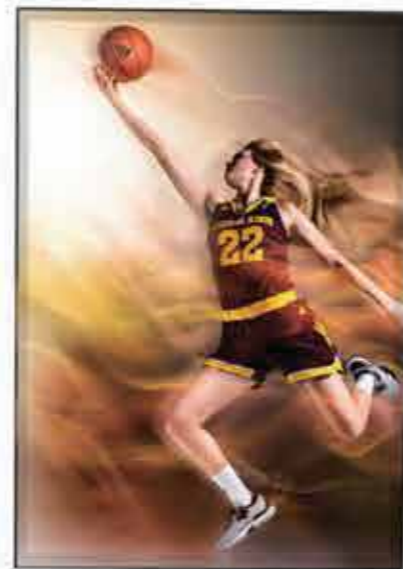

Pop Up A Frame

Lightweight, super easy to set up, and compact to store, all these make Pop Up A Frame the ideal marketing solution for all outdoor and indoor trade shows and events. They are also often used at sporting events like soccer tournaments, road races, and charity golf events to promote the event's corporate sponsors. They will display clearly any message or graphics you want even when the space is limited.



Pop Up A Frame (Sewn Graphics) (SKU:PUAF)

- **Material:**
130g Peach Skin Fabric
- **Lead Time:**
24H / 48H
- **Type:**
Horizontal
Vertical
Round
Pear
Tower
- **Size:**
S/ M/ L



Pop Up A Frame (Pasted Graphics) (SKU:PUAFPG)

- **Material:**
130g Peach Skin Fabric
- **Lead Time:**
24H / 48H
- **Type:**
Horizontal
Vertical
Round
Pear
- **Size:**
S/ M/ L

