

Fixed-Load Electrolytic Dressing With Bronze Bonded Grinding Wheels

T. Bifano

R. Krishnamoorthy

H. Fawcett

E. Welch

Precision Engineering Research Laboratory,
Boston University,
Boston, MA

In electrolytic in-process dressing (ELID), a metal-bonded grinding wheel is dressed as a result of anodic dissolution. In this paper we describe experiments to evaluate the potential for ELID on bronze wheels in fixed-load grinding applications. A constant-force grinding apparatus was used to determine appropriate ELID conditions for a 10–20 μm bronze bonded diamond grinding wheel used to machine silicon carbide. A practical implementation of ELID was demonstrated using a low speed bronze bonded diamond wafering saw. Optimum ELID current was determined for different workpiece materials, and the wear rate of the saw blade using ELID was found to be of the same order as the wear rate of the saw blade using intermittent dressing with a porous ceramic stick. Some of the important factors controlling the rate of dressing by ELID (rate of film growth, rate of film wear and rate of diamond wear) and their combined effects are discussed. Successful use of ELID on bronze-bonded wheels in other applications will be facilitated by understanding these phenomena, developing a general process model based on them and being able to predict useful ELID parameters.

Introduction

Fixed abrasive grinding is the predominant method of machining ceramic and glass materials. By virtue of their hardness, such materials rapidly wear out the diamond cutting edges in the grinding wheel. With some combinations of grinding wheel, workpiece material, and grinding conditions, the grinding wheel bond is eroded by the workpiece at a rate sufficient to continuously expose new, sharp diamond grains while eliminating old, dull grains. Such “self-dressing” processes are rare, unfortunately. More typically, as the diamonds wear out, the grinding process becomes progressively less efficient. Worn diamonds in the grinding wheel usually lead to increased grinding force, increased grinding damage, and increased specific grinding energy.¹ Figure 1 illustrates an example of the increase in specific grinding energy as a function of the total volume of material removed from a workpiece for an ultra-precision grinding operation on a ceramic workpiece (Bifano et al., 1993). In this process, a 4–8 μm grit bronze-bonded diamond grinding wheel was initially dressed and was then used to blanchard-grind silicon carbide on an ultraprecision grinding apparatus. Scanning electron microscope (SEM) photographs of the surface of the wheel showed indications of dulling of the diamond grains, loading of the wheel with grinding swarf, and loss of diamonds from the wheel surface.

Background

Dressing is generally understood to be the process of restoring grinding wheel efficiency by removing bond material and exposing new, sharp diamonds. Dressing processes can be separated into two types: those that occur during grinding (in-process) and those that occur between grinding operations (off-line). A common method of off-line dressing involves advancing a sacrificial porous ceramic “dressing stick” into the grinding wheel between grinding passes to erode the bond. This

is, for example, the method recommended for dressing diamond wafering saws (Buehler Ltd., 1994). An alternate dressing technique used successfully for ultraprecision grinding of ceramics, is to apply a lapping compound between the wheel and a rigid lap plate (Bifano et al., 1991). In-process techniques offer some advantages: they can potentially lead to more uniform dressing behavior, and they do not require cessation of the grinding process. Where in-process dressing has been used to replace off-line dressing, superior finish and figure control in grinding ceramic and glass components has usually been reported (Ohmori and Nakagawa, 1990; Abe and Nobuo, 1992). An in-process dressing method that has received a great deal of attention in the past several years is electrolytic in-process dressing, or ELID. Significant process improvements have been made possible in precision grinding applications by using ELID in conjunction with cast iron fiber bonded (CIFB) diamond abrasive grinding wheels (Ohmori and Nakagawa, 1990). In the United States, bronze-bonded diamond wheels are generally used for machining ceramics, and iron-bonded wheels are less common. The purpose of the study described in this paper is to explore ELID for bronze-bonded wheels.

It is our intention to describe research on electrolysis on bronze bonds both with and without simultaneous grinding. We will identify and characterize some important dynamic effects in bronze-bond ELID, including electrolytic erosion rate, film growth rate, and film wear rate. We will show how these dynamics can directly affect the grinding behavior, leading to the generation of continuously sharp wheel performance in fixed-load grinding operations. Finally, we will demonstrate a practical implementation of bronze-bond ELID on a diamond wafering saw for a variety of difficult-to-machine materials.

Theoretical Rate of Anodic Dissolution in ELID

In an electrolytic cell, current flows between an anode and a cathode as a result of an applied potential. At the anode, relatively uniform material removal is accomplished through the flow of positive ions from the anode surface. At the cathode, the common reaction is either addition (plating) of material from the anode, or evolution of hydrogen gas. In ELID, the grinding wheel bond is the anode, a graphite block is the cathode, and an electrolyte (often made up of a simple solution of

¹ Specific grinding energy is defined as the ratio of grinding energy input to material removal volume.

Contributed by the Manufacturing Engineering Division for publication in the JOURNAL OF MANUFACTURING SCIENCE AND ENGINEERING. Manuscript received Dec. 1994; revised Nov. 1997. Associate Technical Editor: S. Chandrasekar.

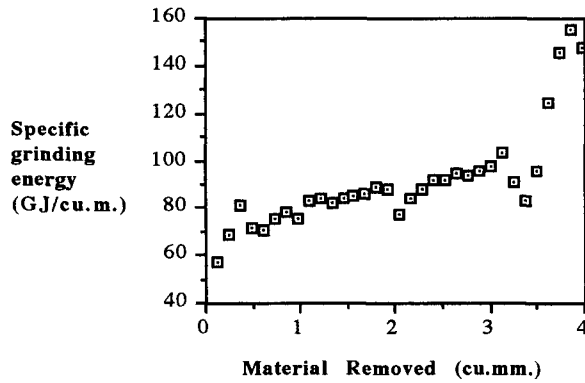

Fig. 1 Specific grinding energy as a function of total material removed in a Blanchard-style micro-grinding operation on CVD silicon carbide. The sharp increase in specific energy is a result of diamond wear (Bifano et al., 1993).

water and conventional rust inhibitor) fills the space between the two. Voltage is applied across the electrodes, usually from a pulsed-DC power supply, allowing the circuit to be completed and thus initiating electrolysis and wheel bond erosion. As the bond erodes, fresh, sharp diamonds are exposed and worn diamonds are washed away. With this arrangement, hydrogen bubbles evolve at the graphite electrode and no changes in cathode shape result from the process.

Faraday (1965) formulated two laws of electrolysis:

- The amount of any substance dissolved or deposited is directly proportional to the amount of charge that has flowed.
- The amounts of different substances dissolved or deposited by the same quantity of electricity are proportional to their chemical equivalent weights.

Based on these laws, we can develop an equation to determine the theoretical rate of anodic dissolution.

From the first law,

$$m \propto Q = It \quad (1)$$

where

- m = total mass removed from the anode
- Q = total charge passing through the electrodes
- I = current
- t = reaction time

From the second law,

$$m \propto \frac{M}{z} \quad (2)$$

where

- M = atomic weight of the reacting ions
- z = valence of the reacting ions
- M/z = chemical mass equivalent of ions

Combining equations (1) and (2), we have

$$m = \frac{Mit}{zF} \quad (3)$$

where F = Faraday's Constant ($F = 96485$ C)

The volume of anode material removed is

$$v = \frac{m}{\rho_a} = \frac{Mit}{\rho_a zF} \quad (4)$$

where ρ_a = density of the anode material.

Table 1 Specifications of ELID power source

Voltage	75 or 150 Volts
Current	0-35 Amps
Pulse On Time	0.1 to 500 μ s (independent of off-time)
Pulse Off Time	1.0 to 500 μ s (independent of on-time)

The rate at which anode material is removed (assuming that I is independent of time²) is

$$\frac{dv}{dt} = \frac{MI}{\rho_a zF} \quad (5)$$

Also, from Ohm's Law

$$V = IR \quad (6)$$

$$R = \frac{\rho_r l}{A} \quad (7)$$

where

- V = Potential across the gap
- R = Resistance of electrolyte between electrodes
- ρ_r = Specific resistance or resistivity of the conductor
- l = length of conductor (width of the gap between workpiece and the electrode)
- A = cross-sectional area of conductor (area of overlap between workpiece and the electrode)

Therefore, the volumetric material removal rate is

$$\frac{dv}{dt} = \frac{MVA}{l\rho_a\rho_r zF} \quad (8)$$

When a particular wheel and electrode are chosen, this rate depends only on the following parameters:

- Potential across the gap, V
- Width of the gap between workpiece and electrode, l
- Conductivity of electrolyte, $1/\rho_r$

ELID Experiments on Bronze Bonded Grinding Wheels

The power source used for all experiments was a pulsed-DC power supply³ which was designed for use in electric discharge machining (EDM) and modified for our experiments. Table 1 shows the source specifications.

Effects of Electrolysis on the Grinding Wheel. An initial qualitative experiment was performed to study surface features in of the bronze bond, or a specific diamond when it is subjected to electrolysis (Welch, 1993). Pieces cut from a bronze grinding wheel, of size 6 mm \times 6 mm \times 35 mm were used for the test.

A series of reference marks were put into the bronze surface using a diamond scribe so that the same region could be re-examined after each test. Specific diamonds in the grinding wheel could then be located relatively easily using this technique.

The anode was subjected to a period of electrolysis and then removed for inspection under the SEM. This cycle was repeated several times. The experimental parameters used for these experiments are summarized in Table 2. Figure 2 shows two pho-

² In Pulsed DC ELID, this rate will depend on the weighted average of l .

³ D-35 M-arc from C. L. Design, Inc.

Table 2 Settings for qualitative study of bond surface

Gap width	380 μ m
Applied Voltage	4 Volts
Electrolyte	1M NaCl
Anode Area	200 mm ²
Test Duration	1.50 seconds

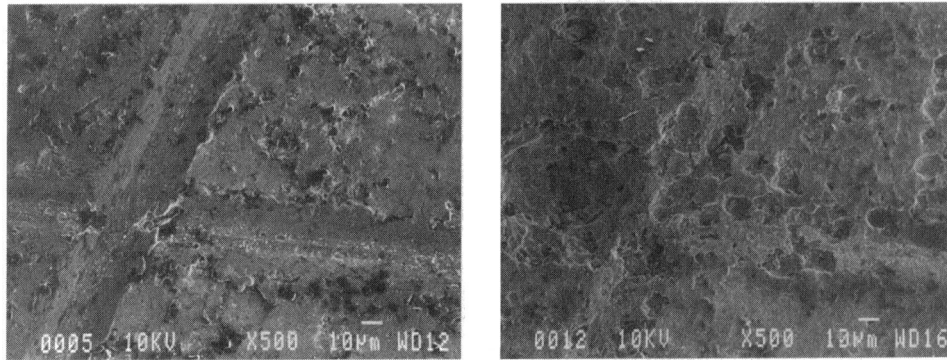

Fig. 2 Photos of a region of bronze anode before and after electrolysis. Evident in the photos are the reference marks used to return to the same place on the anode, and the pitting brought about by the electrolysis.

tos of the exact same region of an anode at 500× magnification—one prior to any electrolysis, the second after 150 seconds of electrolysis at four volts and with a 380 μm gap. The surface of the bronze after electrolysis exhibited some pitting, and the presence of an amorphous oxide film.

Further tests were conducted to study wheel bond erosion rate and film growth rate. A trued 10–20 μm grit bronze-bonded cup-shaped diamond grinding wheel was subjected to electrolysis *without* any workpiece contact. The electrolyte solution used in these experiments was an aqueous sodium chloride solution whose molarity (conductivity) was varied to change the electrolytic current density. A gap distance of 250 μm was established between the wheel and a graphite cathode. Through a graphite brush contact, the grinding wheel was made the circuit anode, and maintained at ground potential. Electrolyte coolant solution was flooded into a reservoir using a constant flow-rate, one-pass coolant delivery system. The graphite cathode and the lower portion of the grinding wheel were submerged in this electrolyte reservoir. The grinding wheel was rotated at 200 rpm by a servo-controlled DC motor. Temperature and conductivity of the electrolyte were measured at one minute intervals, and circuit voltage and current were measured at three second intervals. The settings for the electrolysis experiments are summarized in Table 3.

A radial reference groove was cut into the surface of the wheel. This reference groove is depicted schematically in Figure 3. Before each electrolysis test, the surface of the wheel was chemically etched with a three part solution of distilled water, hydrogen peroxide (3 percent), and ammonium hydroxide (30 percent). Using a capacitive displacement gauge,⁴ contour profiles of the grinding wheel surface were measured. Measurements were made around the circumference of the cup face, recording height variations of the wheel face as a function of rotational angle. These contour measurements included a profile trace across the reference groove, which served as a datum for circumferential and axial position of the original wheel surface

⁴ ADE Microsense 3401.

Table 3 Settings for electrolysis tests in phenomenological study

Parameter	Setting
Voltage	150 Volts, Pulsed
Electrode Gap	250 μm
Duty Cycle	50%
Cathode Area	55 mm^2
Electrolyte	0.0002M NaCl
Flow Rate	140 ml/min (reservoir volume: 100 ml)
Wheel Speed	200 rpm
Wheel Type	6A2 Cup, bronze bond, 10-20 μm , Conc. 100
Wheel Geometry	101 mm outer diameter, 89 mm inner diameter
Test Duration	0-180 minutes, in 10 minute increments

contour. Before each electrolysis experiment, the groove was protected with a temporary coating of cellulose nitrate.

Once a test was completed, the surface of the wheel was cleaned with methanol and allowed to dry for ten minutes. The cellulose nitrate was then removed from the grooves with acetone, and the capacitance gauge was used to re-measure the wheel profile. Such measurements revealed that a film had grown on the surface of the wheel. Resistance measurements proved that this film was not a good electrical insulator. The wheel profile was subtracted from the initial reference profile of the wheel, yielding a measure of the thickness of the film that grew on the surface of the wheel. In this way an average *film thickness* was determined as a function of electrolysis time. Once the film thickness was determined, the reference groove was again protected by cellulose nitrate and the film on the surface of the wheel was removed by exposing the wheel to a 7 percent HCl solution for two minutes, rinsing with methanol, drying for ten minutes, exposing the wheel to a 2 percent H_2SO_4 solution, rinsing with methanol, and drying for another ten minutes. HCl and H_2SO_4 solutions were chosen since they remove oxide films from bronze without significantly affecting the bronze underlayer. The protective coating on the groove was again removed and the wheel profile was re-measured. Subtracting this profile from the reference profile yields a measure of how deep the film extended into the bronze bond. The average extent of the film below the original surface, which we call the *electrolytically affected depth*, was recorded as a function of electrolysis time. The film grew both into and out of the surface of the wheel during the electrolysis. Figure 4 graphically depicts this growth.

Faraday's law predicts that the material removal rate under the conditions used in this test should be about 1.7 nm/s. The calculation (based on equation 8, and using the average voltage) uses the parameters shown in Table 4.

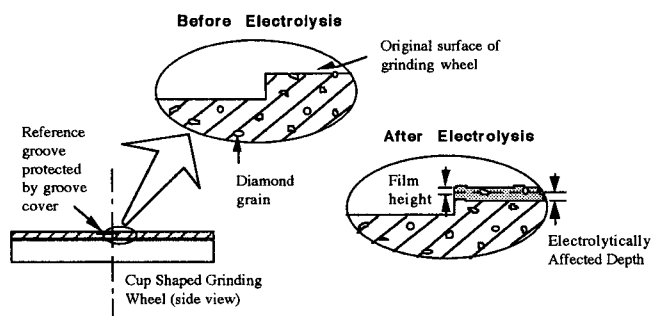

Fig. 3 Schematic showing the reference groove and film formation both above and below the original wheel surface

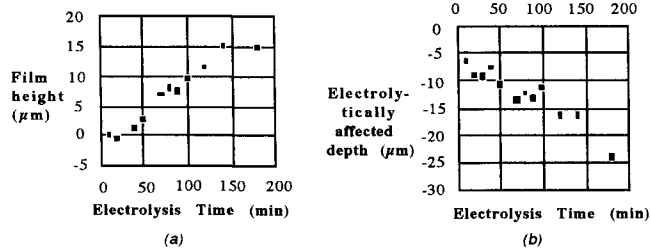

Fig. 4 Oxide film growth as a function of time (a) film height above original surface (b) film depth below the original furnace (Welch, 1993).

Table 4 Parameters used in calculation of theoretical material removal rate for bronze

Atomic weight, M	63.546 g
Potential across the gap, V	86 V
Cathode area, A	55 mm ²
Gap width, l	250 μm
Conductivity of electrolyte, $1/\rho_e$	45 μΩ ² cm ³
Density of copper, ρ_a	8.96 g/mm ³
Valence of copper, z	+2
Material removal rate, dw/dt	3.2x10 ⁻² mm ³ /s

In an actual grinding process, it would be expected that the erosion rate of the oxide film due to abrasion would be greater than the rate of oxide film generation. In that case, the dressing rate or rate of wheel recession would be equal to the rate at which the film grows into the wheel. The experimental rate of bond erosion is then equivalent to the rate of change of the electrolytically affected depth, which can be estimated from the data in Fig. 4b at about 1.5 nm/s. Therefore, the observed dressing rate is fairly close to the predicted dressing rate based on Faraday's laws.

The actual rate of regression of the wheel during grinding may not be the same as the theoretical anodic dissolution rate because there are other important factors that influence this rate. Principal among these are the effects of the oxide films themselves on electrolytic process dynamics, and the rate of oxide film wear due to workpiece contact forces. A more detailed consideration of these factors is discussed later in this paper.

ELID on Constant Force Grinding Apparatus. For ELID to continually expose sharp diamond edges in an actual grinding process, the film that results from electrolysis must be continuously eroded. To explore the dynamics of this process, a constant force grinding apparatus was constructed. Figure 5 illustrates a schematic of this constant force grinding apparatus. Included in the figure is a summary of the parameters used in these experiments.

Samples of hot-pressed silicon carbide were used as workpieces and a constant force of 5N was applied during grinding. This normal force was selected because it is close the force

- Bronze cup wheel
- 100 mm diameter, 6 mm rim
- 10-20 μm diamond, 75 conc.
- 1 m/s wheel speed
- 5 N constant-force grinding
- HP SiC workpiece
- 6 mm x 9 mm contact area
- 250 μm electrode gap
- 0.0002 M NaCl coolant (Low Current)
- 0.002 M NaCl coolant (High Current)
- 150 Volts DC or pulsed DC (1000 Hz, 50% Duty Cycle)

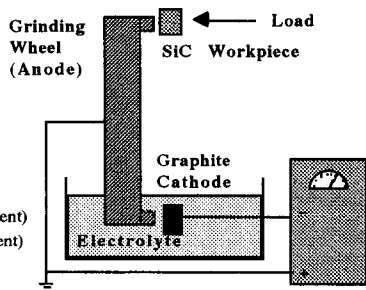

Fig. 5 Constant force ELID grinding apparatus

Table 5 Testing conditions for constant force grinding apparatus

Test Type	Conductivity of NaCl Solution
No ELID	0.0002M
No ELID	0.002M
Pulsed DC ELID (~0.001 A/mm ²)	0.0002M
Pulsed DC ELID (~0.100 A/mm ²)	0.002M
DC ELID (~0.001 A/mm ²)	0.0002M
DC ELID (~0.100 A/mm ²)	0.002M

levels previously measured in a successful ultra-precision grinding process with this workpiece material, grinding geometry, and wheel (Bifano et al., 1991). The wheel speed chosen was lower than that normally used in grinding, to avoid coolant splashing and to ensure that the inter-electrode gap was completely filled with electrolyte. Grinding tests were conducted both with and without ELID. Voltage, current, coolant conductivity, temperature, and grinding rate were measured during the experiments. Electrolysis current was adjusted by varying the concentration of NaCl in the electrolyte solution. Table 5 summarizes the testing conditions.

In constant-force plunge grinding, the grinding process efficiency can be measured by observing the cumulative material removal volume or cumulative depth-of-removal.⁵ If the wheel becomes dull or loaded with debris, or if an electrolytically-induced film obscures the diamond grains, the material removal rate will steadily decline, resulting in an asymptotically limited cumulative material removal depth. If the wheel is successfully dressed in-process, the material-removal rate will reach a steady-state value, and cumulative material removal depth will increase linearly with grinding time. In the best case of successful dressing, the steady state material removal rate will be the same as the rate achieved by a sharp, new wheel. Figure 6 summarizes the results of the constant force grinding experiments.

In all of the experiments involving no ELID or DC ELID, the grinding wheel became dull over a period of approximately 20 minutes, after which minimal amounts of material were removed from the workpiece. With low current pulsed DC ELID (0.0002 M NaCl electrolyte), the cessation of cutting was delayed by approximately 10 minutes. When high current pulsed DC ELID (0.002 M NaCl electrolyte) was used, the first 20 minutes saw a slightly lower amount of material removal than the other ELID and no ELID experiments; however, unlike the other tests, after this 20 minutes, the depth of material removed increased linearly, thus indicating a uniform, steady-state material removal rate. The high current pulsed DC ELID experiment

⁵ In plunge grinding, the cumulative removal volume is the wheel width multiplied by the cumulative depth-of-removal or infeed.

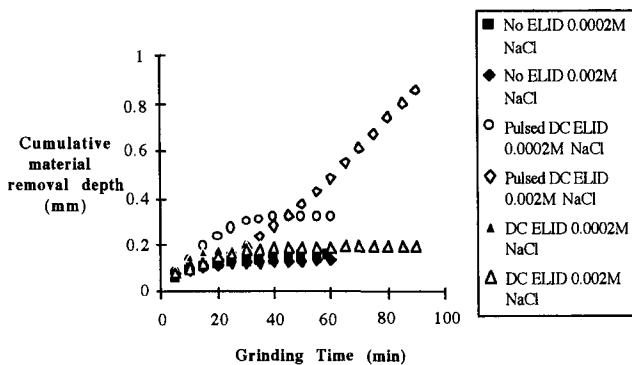

Fig. 6 Cumulative depth of removal as a function of grinding time in constant-force plunge grinding with various ELID conditions. The only condition resulting in satisfactory dressing was high-current, pulsed DC electrolysis.

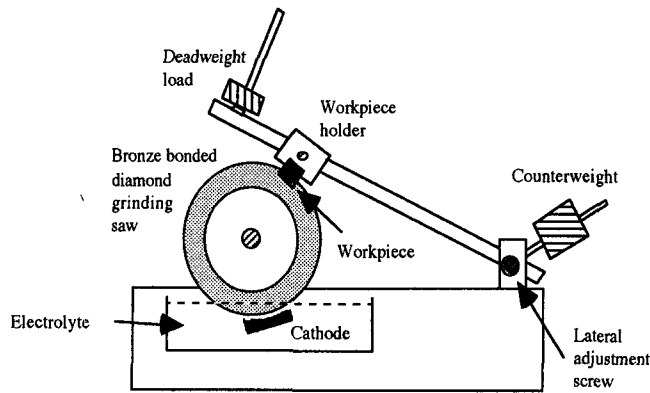

Fig. 7 Schematic of cutoff saw with retrofitted ELID apparatus

maintained the material removal rate at a level within 10 percent of the initial sharp wheel performance.

The different ELID experiments provided different films that grew on the surface of the wheel. For the unsuccessful bronze ELID experiments, when material removal ceased, a black film was observed on the wheel, indicating the presence of Copper (II) oxide, whereas the high current pulsed DC ELID initially showed the formation of a green film for the first 20 minutes of an experiment, indicating the presence of Copper (I) oxide. The results illustrated in Fig. 6 indicate that ELID can be used successfully with bronze-bonded grinding wheels.

Implementation of ELID on a Cut-off Saw. A practical implementation of ELID was demonstrated and studied using a diamond grit, bronze-bonded cut-off saw designed for precision, low deformation sawing and wafering⁶ (Krishnamoorthy, 1994). This type of machine is used extensively in industry, typically for sample preparation. A schematic of the cut-off saw complete with a retrofitted ELID sub-system is shown in Fig. 7.

When cutting ceramics or glasses, the diamonds in the wafering blade become dull relatively quickly. Dressing is usually accomplished by periodic application of a porous ceramic "dressing stick" pressed against the wheel's perimeter. The potential for ELID in this situation is to allow automation of the sample preparation process and to allow more uniform sawing performance. The experimental setup parameters are summarized in Table 6.

It was decided to use rust inhibitor in distilled water as the electrolyte, because it gives the same conductivity ranges as NaCl in water, and has the added advantage of acting as an anti-rust and anti-corrosion agent. Inhibitor 42, a water-based metalworking fluid concentrate manufactured by Cincinnati Milacron was used in distilled water. Table 7 lists the relevant properties of Inhibitor 42.

The first experiment was designed to study the effect of turning on ELID when the wafering blade performance had deteriorated (i.e. material removal rate was very low in comparison to sharp wheel performance). The experiment studied the nature

⁶ Buehler ISOMET Low Speed Saw.

Table 6 Setup parameters

Blade geometry	102 mm diameter, 0.3 mm thick
Blade type	Low Concentration
Cathode	Graphite
Electrolyte	Rust Inhibitor in distilled water (300-500 μ S/cm)
Gap Width	254-381 μ m (0.01-0.015 inch)
Area of electrode	2.44 mm ²
Voltage	75 V / 150 V
Duty Cycle	50 % (Square Wave)

Table 7 Characteristics of inhibitor 42 supplied by manufacturer

Boiling point	212 °F
Specific gravity	1.248
pH (concentrate)	9.8-10.2
Solubility in Water	100%

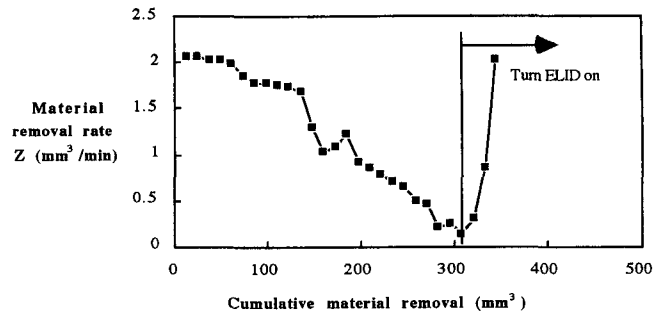

Fig. 8 ELID used to restore wheel performance when the blade is dull. After 300 mm³ of removal, the material removal rate had decreased by more than an order of magnitude. The ELID system was then activated, and it rapidly restored the wheel's cutting performance.

of the blade dulling without any dressing, and subsequently the effect of turning on ELID.

Figure 8 shows the material removal rate (calculated as the product of sample cross-section and wheel width) as a function of cumulative material removal for a glass workpiece having a 6.4 mm \times 6.4 mm cross-section. The blade was initially dressed to sharp condition and then the sample was cut 29 consecutive times. The blade started to noticeably lose its cutting efficiency after about 10 cuts and its performance rapidly deteriorated after about 20 cuts. At the 26th cut, the material removal rate was more than an order of magnitude lower than at the first cut. ELID was turned on at this point. As seen in the figure, the material removal rate increased to its starting value within three cuts. ELID, therefore, effectively dressed the wheel to bring it back to its original cutting condition.

The next set of experiments was aimed at determining the optimum parameters for *continuous ELID*. The materials used with the cut-off saw included chemically vapor deposited silicon carbide, Zerodur glass ceramic and silicon nitride. The ELID parameters with each of these materials is summarized in Table 8. ELID proved to be successful in all cases, once the proper parameters were found. To determine if ELID is more successful than the current dressing methods, duplicate experiments were done on the apparatus. Experiments were performed using an initially dressed wheel with no subsequent dressing and the experiments were repeated with continuous ELID used as the dressing technique. Without ELID, the performance of the wheel progressively deteriorated. With continuous ELID, this progressive decline did not occur. Figures 9-11 shows the results of these experiments with Zerodur Glass, CVD silicon carbide and silicon nitride, with the vertical axis showing the material removal rate and the horizontal axis showing the cumulative material removal.

In grinding tests on Zerodur glass without dressing, material removal rate decreased continuously (Fig. 9). With continuous

Table 8 ELID parameters when cutting different materials

Material	Sample size (mm ²)	Deadweight load (gms)	Pulsed DC Voltage	Electrolyte Conductivity (μ S)	Electrolytic gap (μ m)	Blade Speed (rpm)
Zerodur Glass	6.4 x 6.4	25	150 V 1000 Hz	300	381	180
CVD SiC	8.25 x 3.0	150	150 V 1000 Hz	500	254	180
Si ₃ N ₄	7.96 x 4.85	150	150 V 1000 Hz	500	254	180

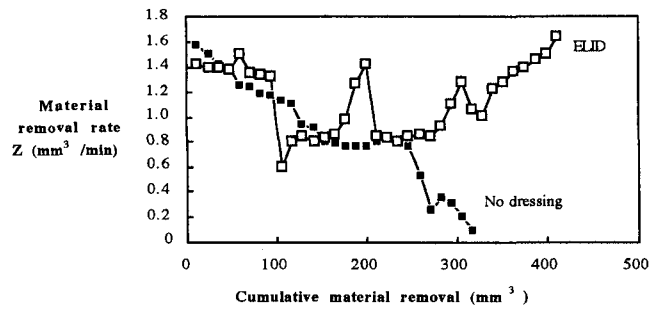

Fig. 9 Material removal rate vs cumulative material removal for Zerodur glass ceramic

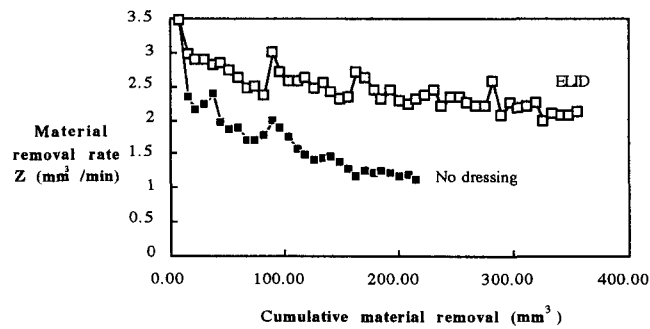

Fig. 10 Material removal rate vs cumulative material removal for CVD silicon carbide

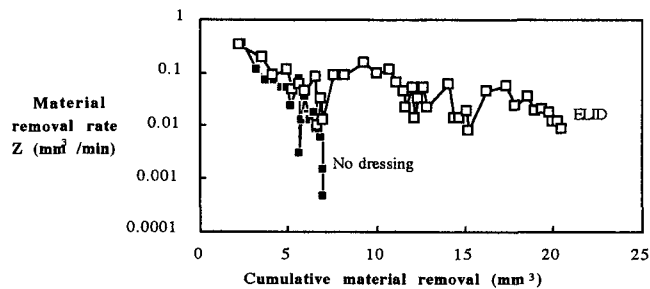

Fig. 11 Material removal rate vs cumulative material removed for silicon nitride. The material removal rate axis is plotted on a logarithmic scale.

ELID, the material removal rate exhibited periodic fluctuations, declining somewhat and then returning to its initial value several times over the course of several hours of grinding.

In grinding tests on chemically vapor deposited silicon carbide, material removal rate remained higher with ELID throughout the test.

In grinding tests on silicon nitride, the material removal rate initially declined rather sharply, both with and without continuous ELID. Following this, the wheel ceased cutting entirely when it was not dressed. However, when subjected to continuous ELID, the wheel continued to cut, though its material removal rate steadily declined throughout the test.

Figure 12 shows the maximum gap voltage and maximum current as a function of time during a continuous ELID test where 35 cuts were taken through a 6.4 mm × 6.4 mm sample of Zerodur glass. It was observed that electrolysis current declined for the first 200 mm³ of material removal and then remained approximately constant. The voltage remained approximately constant for the duration of the test. The current decline is similar to that observed for ELID on iron-bonded wheels (Ohmori and Nakagawa, 1990).

A comparative study was made of the rate of wear of the blade with ELID and with stick dressing. The wear was mea-

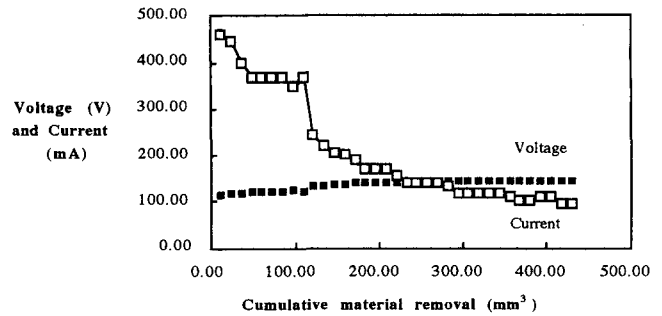

Fig. 12 Electrical behavior during electrolytic dressing of bronze bonded diamond wafering blade

sured by measuring the distance of the edge of the blade from a fixed reference point in the interior of the blade. Three such reference points were used to account for stray errors. Three reference holes of 1.5 mm diameter were drilled 120 degrees apart along the circumference of the wheel in the bronze core at the edge of the circumferential rim of bronze bonded diamond. The distance to the edge of the wheel was measured with respect to the near end and with respect to the far end of the reference hole along a line containing the diameter of the hole and perpendicular to the tangent at the point where it intersects the blade rim. Two measurements were thus made per hole, giving a total of six data points. By making these measurements periodically over the course of a series of cutting experiments, wheel wear was determined.

For wheel wear measurement with stick dressing, the blade was initially dressed to maximum cutting efficiency. A measurement was made at the start of the experiment representing no wear condition and subsequently, measurements were made after every five cuts. A total of 60 cuts were made through a CVD SiC sample having a cross-section of 8.25 × 3 mm² for each of the two dressing types—continuous ELID and intermittent porous stick dressing. To make the stick dressing results comparable to the ELID results (for which the cutting time remains approximately constant), the blade was dressed every time the cutting time increased to 125% of the initial cutting time.

Figures 13(a) and (b) show the wheel wear with ELID and with stick dressing when cutting silicon carbide. The average wear showing maximum and minimum recorded values is shown in the figures. The results indicate that the rate of wear with ELID and the rate of wear with stick dressing are of the same order when cutting CVD SiC.

An experiment was conducted to determine the effect of continuous ELID dressing on saw blade trueness by studying it as a function of dressing time. The blade which began with an out of roundness of 25 μm had progressed to an out of roundness of 125 μm at the end of 180 minutes of continuous ELID. Out of roundness was measured based on the wear rates of the three selected points along the blade circumference. The deterioration of wheel trueness resulting from continuous ELID is a concern in precision engineering applications. It is unclear whether the cause of the wheel's out-of-roundness is due to an intrinsically non-uniform rate of electrolysis on bronze-bonded wheels (i.e. such as might be expected by the pitted features observed in initial phenomenological studies described earlier), or whether it is due to other factors.

ELID is a continuous, "in-process" method of dressing. Ideally, it should uniformly remove the blade (or wheel) bond. However, at a microscopic scale, the process is far from uniform and continuous. Metal dissolution and film nucleation occur at preferred sites, and impurity effects result in non-uniform film growth. The process will be more controllable if the blade and electrolyte were made of a single material. However, in the experiments described here, the exact composition of the blade

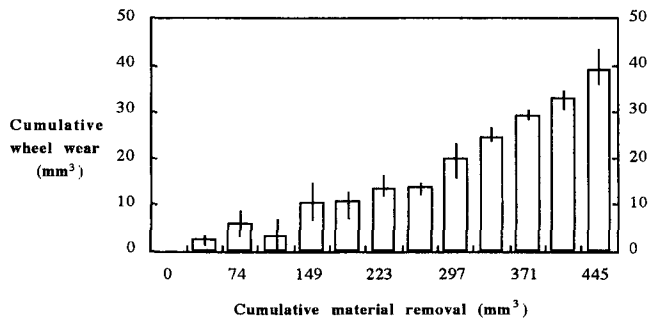

Fig. 13(a) Wheel wear with ELID for CVD silicon carbide

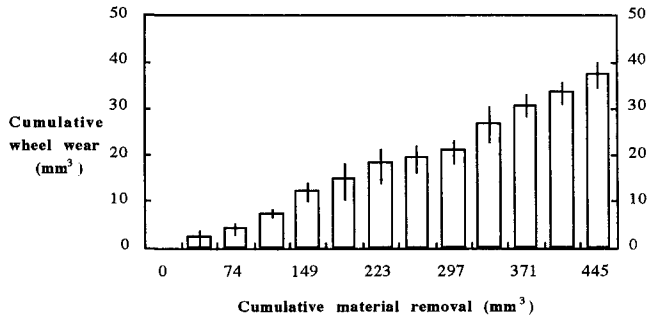

Fig. 13(b) Wheel wear with stick dressing for CVD silicon carbide

and electrolyte were unknown. The bronze bond in the blade is likely to contain cobalt and silver in addition to copper and tin, and the rust inhibitor used in the electrolyte is a combination of chemicals.

A portion of the film that grew on a wafering saw blade subjected to ELID was subsequently scraped from the surface and characterized using x-ray diffraction on a Nicolet diffractometer. The film was soft, and fairly easily removed from the bronze. It proved to be amorphous based on the diffraction results, which is consistent with its lack of adhesion and relative friability.

Discussion

Dressing rate by ELID is directly dependent on the ELID current, which in turn is dependent on the voltage, electrolyte conductivity and the electrode gap. However, the theoretical rate of anodic dissolution is not the actual rate at which the wheel is being dressed. In an actual grinding process with ELID and workpiece contact, there are a number of dynamic processes involved. Principal among these are:

- wear of the diamond abrasive grain edges
- anodic dissolution of the metal surface
- oxide film formation on the metal surface
- erosion of the oxide film due to contact with the workpiece

If one could develop a model of ELID based on these process rates it would be possible to theoretically predict the ELID current required for a given grinding configuration.

The rate of diamond wear depends on the grinding contact stresses, the workpiece properties, and the diamond grain properties. The progression of wear in typical diamond grinding processes is such that the freshly dressed wheel cuts efficiently for a time, then begins to lose its efficiency. Grinding forces rise and the surface of the ground workpiece becomes rougher and less uniform. Wear processes on diamond grains are relatively independent of electrolytic dressing conditions. By virtue of this independence, it may be possible to adjust the dressing rate in ELID such that new, sharp diamonds are exposed at a rate sufficient to ensure acceptable grinding performance.

The rate of oxide film formation depends principally on electrochemistry and is independent of the workpiece material and the grinding conditions. Film growth rate in electrolysis has been shown to follow one of two similar trends, depending on the relative field electric field strength at the anode. For low fields, the ionic current is proportional to the electric field strength in the film, and the thickness of the film varies as the square root of time: $x \propto \sqrt{t}$. For high fields, the ionic current is an exponential function of the electric field strength and the thickness varies as the logarithm of time: $x \propto \log t$. The results from our experiments on the dynamics of film formation (Fig. 4) fit either growth curve (low field or high field) within experimental error.

For bronze bonded wheels, the film formed is an amorphous oxide compound. Without workpiece contact, this film eventually obscures the grinding wheel diamonds. With workpiece contact, the oxide film formed on the surface of the wheel due to electrolysis is eroded due to abrasion with the workpiece being cut.

The rate of wear of the oxide film depends on the hardness of the workpiece material, the characteristics of the film itself (e.g. hardness, adhesion strength), and on the load. For a constant load, and a particular apparatus and workpiece material, we can assume that the rate of wear of the film will be constant: wear processes erode the film linearly with time.

The effective film thickness at a given time depends on the nature of the film growth rate and on the film wear rate. Since the rate of growth of the film is non-linear and the rate of wear is linear, the combined effect can be described mathematically by a non-linear, first-order ordinary differential equation.

If at time t , the film thickness is given by x_g , then

$$x_g = a \log t \quad (9)$$

where a is a constant related to film growth and depends only on the electrochemistry of the system.

The rate of growth of the film is given by

$$\frac{dx_g}{dt} = \frac{a}{t} \quad (10)$$

The rate of film growth can be expressed as a function of current film thickness rather than as a function of time.

$$\frac{dx_g}{dt} = ae^{-x/a} \quad (11)$$

The rate of film wear is a constant and is given by

$$\frac{dx_w}{dt} = -b \quad (12)$$

where b is a constant related to the film wear, and depends only on material properties of wheel bond and material workpiece.

The effective film thickness is therefore given by the differential equation

$$\frac{dx}{dt} = ae^{-x/a} - b \quad (13)$$

where x is the film thickness, and a and b are constants depending on the electrochemical and tribological parameters of the system respectively.

The initial conditions for the process are

$$\text{At } t = 0, x = 0 \text{ and } \left(\frac{dx}{dt}\right)_{t=0} = (a - b)$$

The analytical solution to this equation is implicit in x and t and is given by

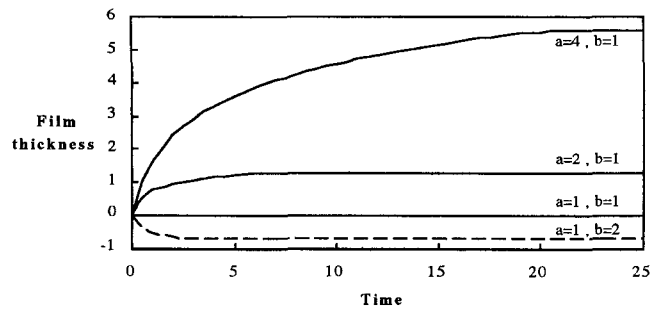

Fig. 14 Effective film thickness as a function of time for different a and b , simulated numerically from the differential equation. Film thickness and time are in arbitrary units.

$$\frac{x}{a} + \log\left(\frac{ax^{-x/a} - b}{a - b}\right) + \frac{b}{a}t = 0 \quad (14)$$

Figure 14 shows a family of curves which are the simulated values for film thickness as a function of time for different values of the constants a (which depends only on film growth rate) and b (which depends only on film wear rate).

It is seen that for all values of a and b , the film thickness always attains a steady state value. If $a > b$, the film thickness is some positive value and there will always be a film of constant thickness on the wheel after steady state has been reached. The time taken to reach steady state depends on the relative values of a and b . As a/b increases, the time for attaining steady state increases. If $a < b$, the film thickness is negative. Physically, this is interpreted to mean that the oxide film never forms, because the rate of wear is greater than the instantaneous rate of growth at all times. We observed a thin oxide film on the wheel for all steady-state ELID experiments, leading us to the conclusion that $a > b$ in our case.

The rate of bond erosion is governed by the effective rate of film growth i.e. the rate at which the oxide film advances into the bond. Since the film formation and erosion processes stabilize in such a way that the film thickness is always constant, the rate of bond erosion is constant and the film recession into the bond is a linear function of time. For the wheel to perform effectively, the bond should erode at a rate sufficient to allow diamonds to fall out before they become unacceptably dull. We can assume that a diamond grain will fall out when the bond around it has eroded to a level below the bottom of the diamond. Therefore, to maintain good cutting efficiency, the time taken for bond to erode through a distance equal to the diameter of one diamond should be less than the time taken for the diamond to become unacceptably dull.

If $a \gg b$, the steady state oxide film formed may be thick enough to obscure the diamonds, bringing grinding to a halt. Since a is a characteristic constant depending on electrolysis parameters, a can be varied to choose a suitable value of a/b

such that this does not occur. a must also be chosen to satisfy the requirement that wheel bond recession occurs at a rate sufficient to expose fresh diamonds before the old diamonds become unacceptably dull.

Conclusions

It has been shown that ELID works on bronze bonded wheels. The initial studies on dynamics of film formation showed that an oxide film grows into and out of the wheel surface. Experiments with workpiece contact showed that this film is eroded by the grinding process and it is possible to sustain continued grinding, under certain conditions. A practical implementation of ELID on a cut-off saw has been demonstrated and studied; optimum ELID parameters have been determined for cutting different materials and a wear analysis of the wheel has been performed.

A process model based on the factors affecting dressing rate by ELID has been developed. The rate of growth of the film can be given by a non-linear, first order ordinary differential equation, and the solution of this equation gives the film thickness as a function of time and certain system parameters. The rate of bond erosion is governed by the effective rate of film growth into the bond. To maintain some specified cutting efficiency, the time taken for bond to erode through a distance equal to the diameter of one diamond should be less than the time taken for the diamond to become unacceptably dull.

Acknowledgments

This research was funded principally by a grant from the National Science Foundation (DMI-9202377). Grinding wheels were donated by Norton Company.

References

- Abe, K., and Nobuo, Y., 1992, "Cleaning Technique for Super Abrasive Grinding Wheel with FRP Cleaner," *Proceedings ASPE Annual Meeting*, pp. 83–86.
- Bifano, T. G., Dow, T. A., and Scattergood, R. O., 1991, "Ductile-Regime Grinding: A New Technology for Machining Brittle Materials," *ASME JOURNAL OF ENGINEERING FOR INDUSTRY*, Vol. 113, pp. 184–189.
- Bifano, T. G., Yi, Y., and Kahl, K., 1993, "Fixed Abrasive Grinding of CVD SiC Mirrors," *Journal of Precision Engineering*, Vol. 16 (No. 2), pp. 109–116.
- Faraday, M., 1965, *Experimental Researches in Electricity*, Vols. I, II, III, reprinted by Dover, New York.
- Krishnamoorthy, R., 1994, "Electrolytic In-Process Dressing of Bronze Bonded Diamond Wheels," Master's Thesis, Boston University.
- Ohmori, H., and Nakagawa, T., 1990, "Mirror Surface Grinding of Silicon Wafers with Electrolytic In-Process Dressing," *Manufacturing Technology, Annals of the CIRP*, Vol. 39 No. 1, pp. 329–332.
- Ohmori, H., 1992, "Efficient and Precision Grinding Technique for Ceramics with Electrolytic In-Process Dressing (ELID)," *Proc. Intl Conf on Machining of Advanced Mtls*, NIST Special Publication 847 pp. 359–366.
- Ohmori, H., 1992, "Electrolytic In-Process Dressing (ELID) Grinding Technique for Ultraprecision Mirror Surface Machining," *Japan Soc. Prec. Eng.* Vol. 26 (No. 4), pp. 273–278.
- "Operating and Maintenance Instructions for ISOMET Low Speed Saw," Revised 4/94, Buehler Ltd.
- Welch, E. J., 1993, "Electrolytic Dressing of Bronze Bonded Diamond Grinding Wheels," Master's Thesis, Boston University.