

### Open Frame Touch Monitor

#### HO 165 PTB

39,6 cm / 15.6" Diagonal  
LED Backlight – Format 16:9

- 1920 x 1080 Resolution Full HD 1080P
- 10-Point Touch P-Cap Technology
- 170° Wide Viewing Angle
- Triple Input: HDMI + DP + VGA
- **IP65 Rating Level**
- **Display Protection: Thickness 3.9mm**
- **24/7 Operating**
- **Built-in Speakers**
- Touch-Through Glass
- Sturdy Metal Case
- VESA Mount and Multiple Mounting Options
- Edge to Edge glass without raised frame
- Orientation: Landscape, Portrait, Face-Up

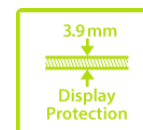
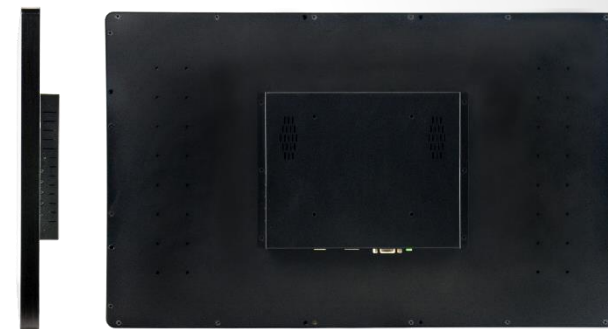

39,6 cm / 15.6"

Part. No.: HO 165 PTB

#### SIZE, RESOLUTION



15.6"  
16:9 Aspect Ratio



Full HD  
1920 x 1080

#### CONNECTIVITY, IP LEVEL



VGA  
HDMI  
Display Port



IP 65  
Water & Dust  
Protection

#### VIEWING ANGLE, VESA

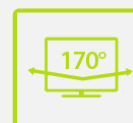

170° Wide  
Viewing Angle



VESA  
Wall-Mountable

#### OTHER FEATURES



Operating  
24 Hours / 7 Days



Speakers

Display Size	39,6 cm / 15.6" Diagonal
Panel Type	TFT – LED Backlight
Aspect Ratio	16:9
Resolution (H x V)	1920 x 1080 Full HD
Brightness	250 cd/m <sup>2</sup> (Panel) – 212 cd/m <sup>2</sup> (Monitor)
Contrast (Typ.)	700:1 (Typical) – 10M:1 (Active Contrast)
Display Area	345,23 x 194,54 mm
Viewing Angle L/R; U/D	170° H / 170° V (CR > 10)
Response Time	25 msec
Pixel Pitch	0,17925 (H) X 0,17925 (V) mm
Touch Type	Projected Capacitive Type – 10 Point Touch Material Glass + Glass Cover Glass+LOCA+ITO (Indium Tin Oxide) Glass
Display Colors	262K Colors
Horizontal Frequency	31.5 ~ 80 kHz
Vertical Frequency	60 ~ 75 Hz
Max Display Frequency	1920 x 1080 @ 60Hz
Input 1	VGA
Input 2	HDMI
Input 3 / 4	Display Port / USB for Touch
Speakers	Yes, 1.5W x 2
Power Consumption	On: 7,3W; Stand-by: 0,4W; Off: 0,2W
AC Power Range	External Power Supply: 12 Volt / 2.5A Input: AC 100 ~ 240 Volt; 50 ~ 60 Hz
Product Dimensions	387,3 x 39,8 x 236,4 mm (W x D x H)
Packing Dimensions	464 x 100 x 325 mm (W x D x H)
Net / Gross Weight	2,46 Kg / 4 Kg (± 0,3 Kg)

VESA Mounting	100 x 100 mm. Screws: M4, 10mm (Max), pitch 0,7 mm
Display Protection	TP Module Protection Thickness 3,9 mm
Hardness / Transmittance	≥6H Toughened hard panel surface / ≥85%
IP Rating Level	IP 65 ** (Front), Water and Dust Protection
Control	Menu/Exit,Bri (+),Vol (-) , Input/Enter,Power
LED Backlight life	15.000 hours
Accessory	Power Adaptor; EU and UK Power Cables (1,5mt); HDMI Cable (1,5mt); USB 2.0 (B-A) Cable (1,8mt)
On Screen Display	8 Languages
Color	9300, 6500, 5300, User Mode
Preset Mode	Standard, Text, Movie, Game Modes
Orientation	Landscape, Portrait, Face-Up

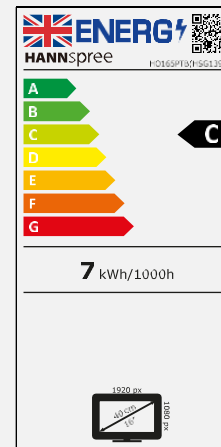
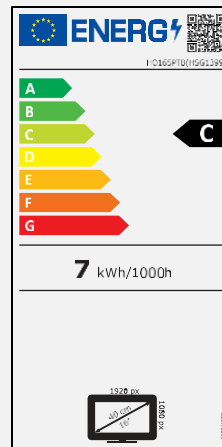

Supplier's Name	HANNspree
Model Name	HO165PTB
Energy efficiency class for standard Dynamic Range (SDR)	C
Annual Energy Power Consumption (kWh/1000h)	7 kWh/1000h
On mode power demand for Standard Dynamic Range (SDR)	7,3 W
Off mode power demand (W)	0,2 W
Standby mode power demand (W)	0,4 W
Screen Diagonal (cm / inches)	39,6cm / 15.6"
Resolution	1920 x 1080

PART. NO.:  
HO 165 PTB

4 711404 023033 >

\* IP65: The IP Code classifies how resistant a device is to foreign objects and moisture. IP65 means that the monitor is protected from total dust ingress and it is protected against low pressure water jets from any direction. Limited ingress permitted.

© 2020 HANNspree Europe Holdings B.V. Specifications and design as well as accessories are subject to change without notice. Screen shots are simulated. Actual products may differ slightly from those illustrated on this promotion material. Please refer to actual samples for final selection. The products displayed on this promotion material may not be available for purchase in your particular country or locality. Please check with your local HANNspree authorized representatives for the availability of specific products in your area. All brand, product, Service names and logos are trademarks and/or registered trademarks of their respective manufactures and Companies.

**HANNSpree**

**HO 165 PTB**  
**15.6" Open Frame Touch Monitor**

Experts in **Display**



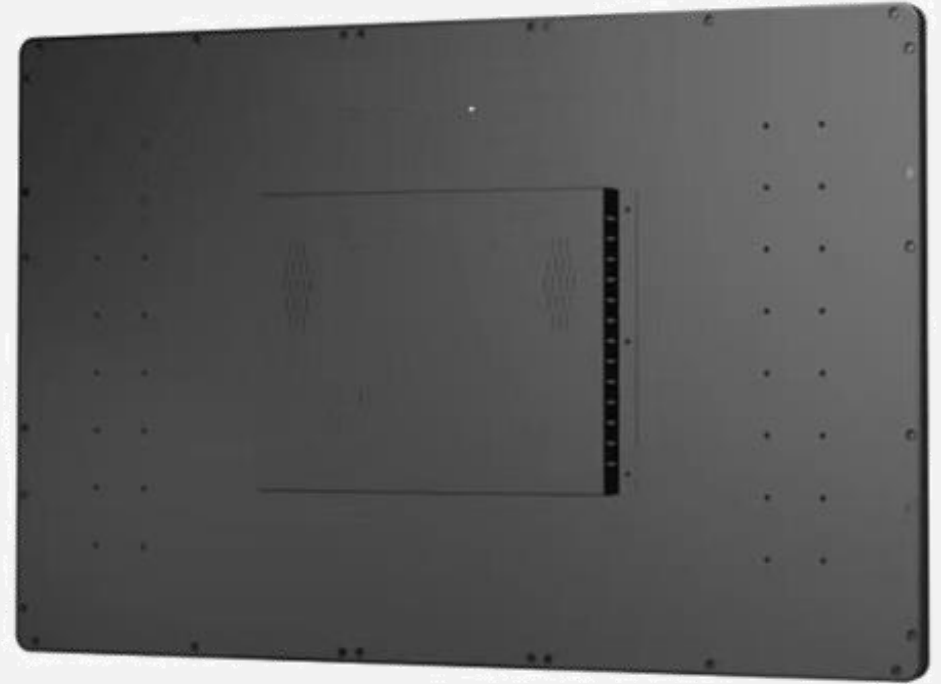
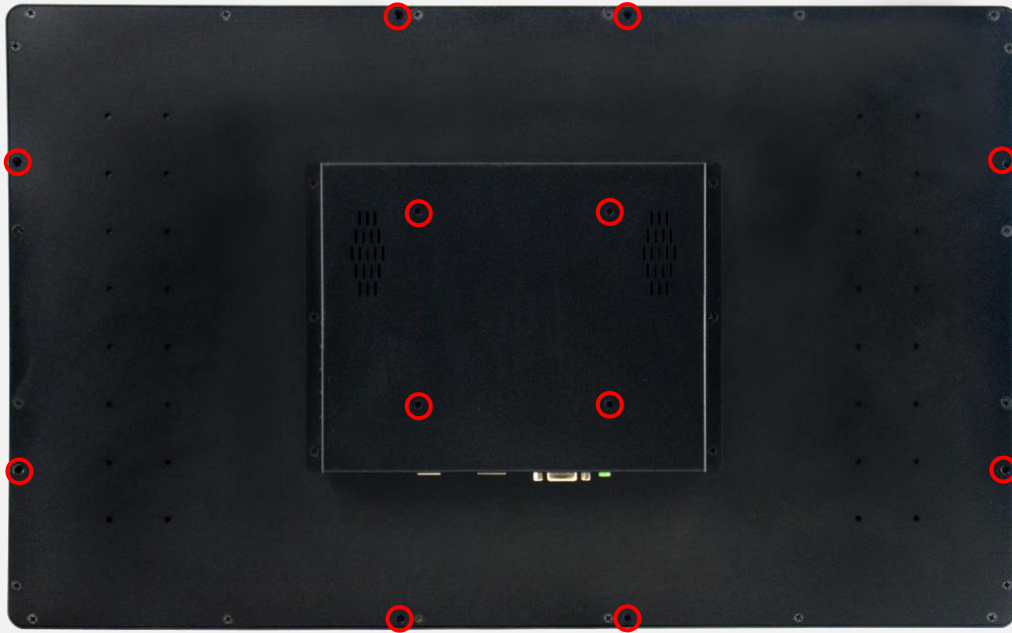

**Front Cover :**

**Full Flat Design**

Screws: M4 x 10mm (max), pitch 0.7, UNC type

## HO 165 PTB 15.6" Open Frame Touch Monitor

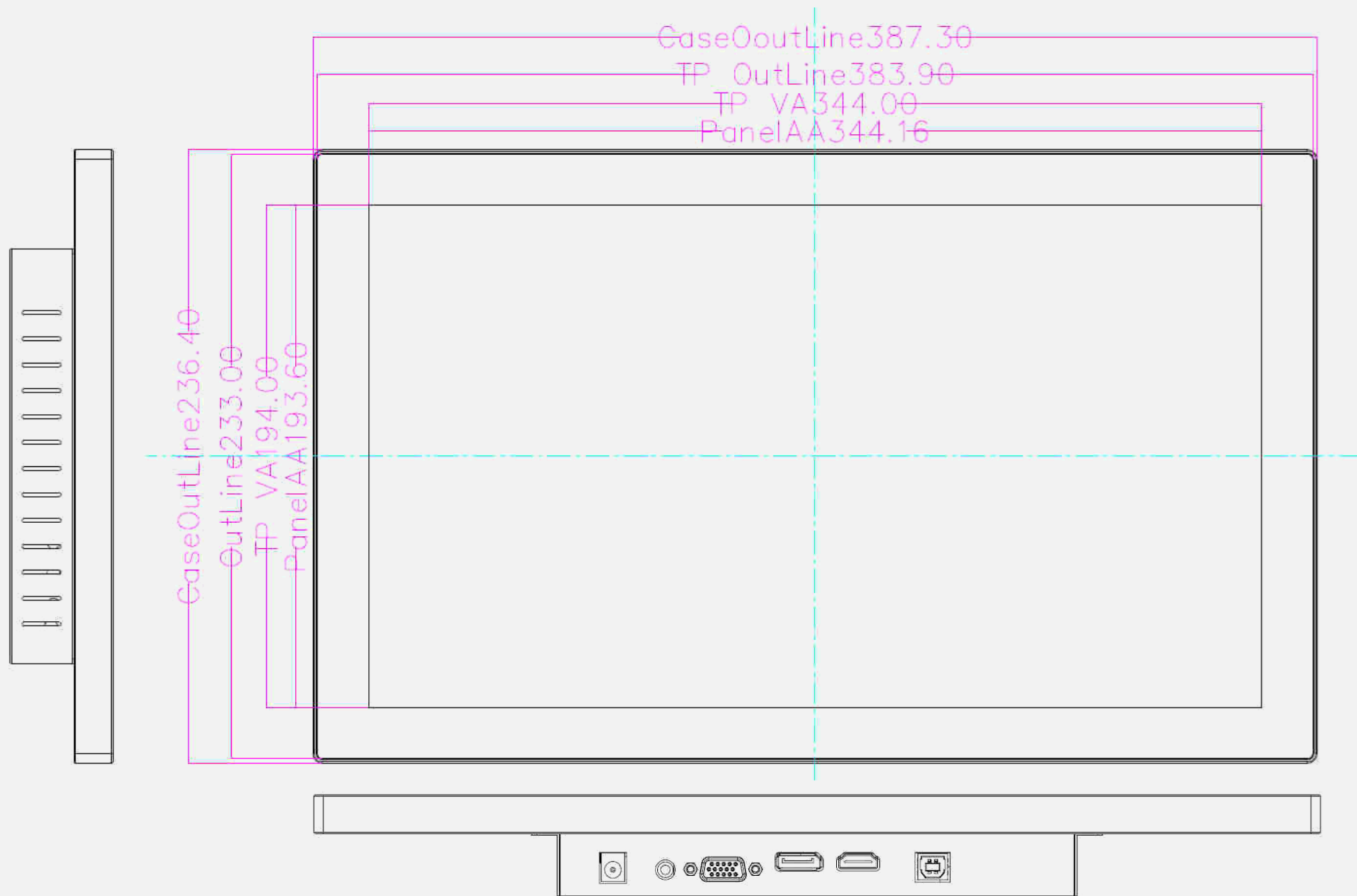

## HO 165 PTB 15.6" Open Frame Touch Monitor

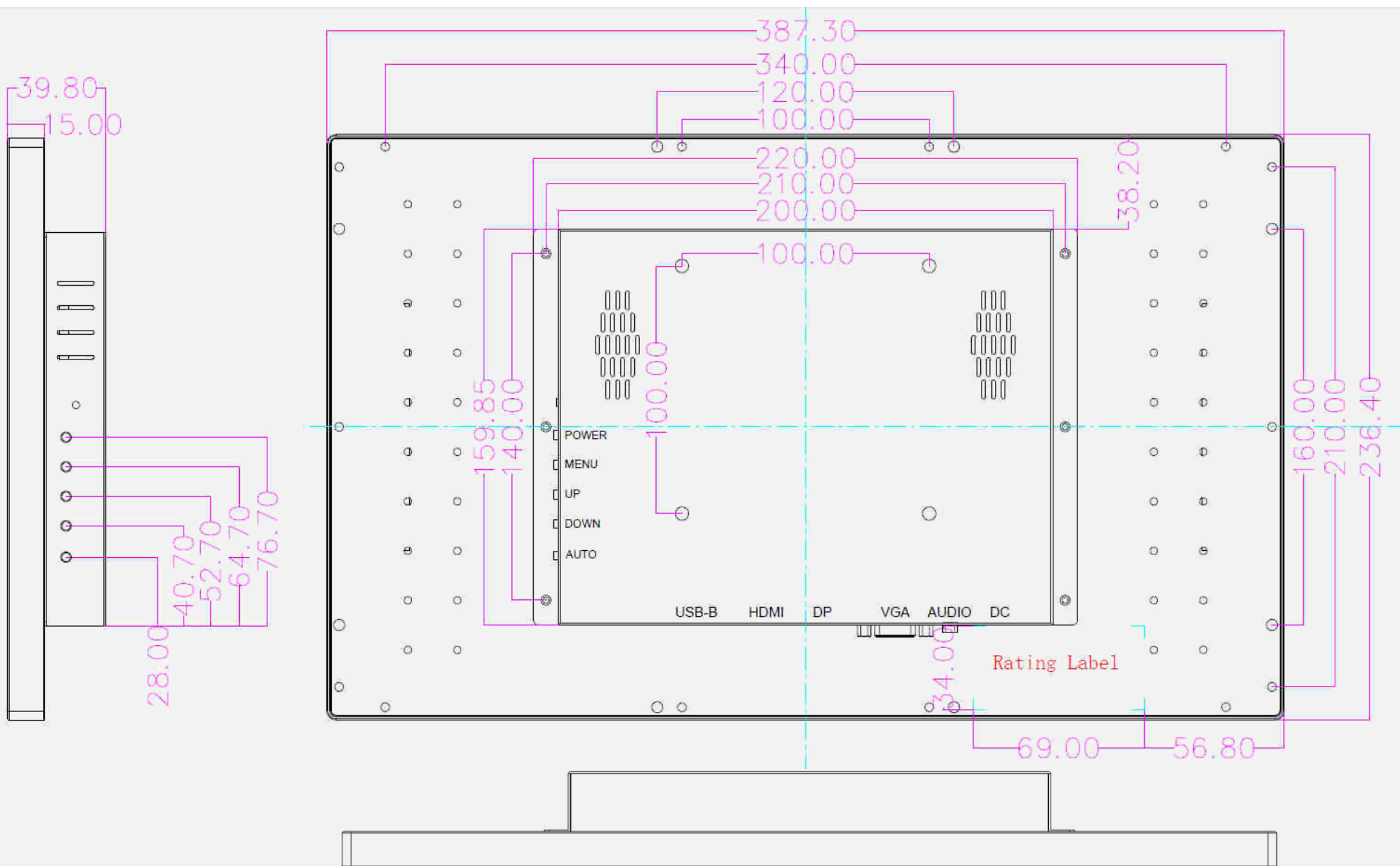

**HANNspree**

**HO 165 PTB**  
**15.6" Open Frame Touch Monitor**

Experts in **Display**

