

FTLT-66G

60 MAGICLOTUS GAS GRIDDLE - TOP

Gas Fry-top smooth griddle, plate
cm.59,5x45 - 2 cooking areas

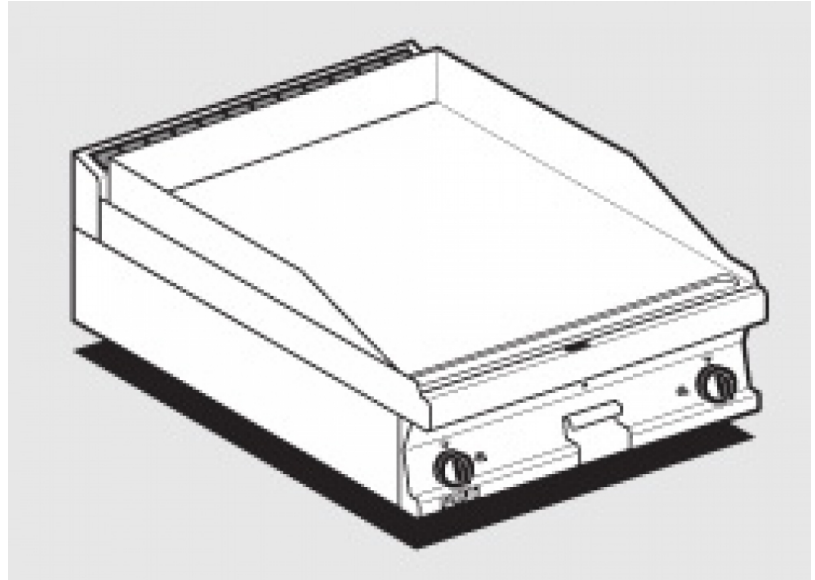

Construction - Fabricated using CrNi 18/10 AISI 304 grade Stainless Steel Scotch-Brite Satin polish Finish, incorporating 2,5mm thick worktop, rounded edges, chromed details and rear splash back. Knobs with waterproof grades IPX5. Model - Professional Gas Griddle, Smooth, Ribbed or 50 / 50, Normal or Chrome. Normal Plate in FE430B Steel and Chrome in FE510C Steel. High durability and rapid heat up. Burners with Piezoelectric ignition and pilot light, 50 - 300degC control, thermostatic and thermocouple safety valves, Removable liquid containers. Maintenance - All serviceable parts are accessible by the easy removal of front control panel. Fittings - Appliance is supplied with both LPG and Natural Gas conversion jets and adjustable feet.

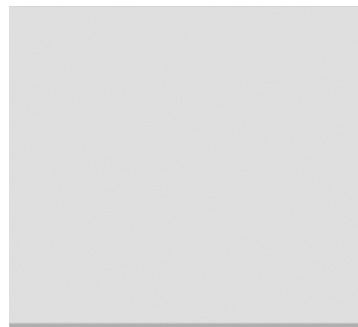

ITALIAN CULINARY ART

The pictures are purely representative. The manufacturer reserves the right to modify the technical data and models without previous notice.

FTLT-66G

60 MAGICLOTUS GAS GRIDDLE - TOP

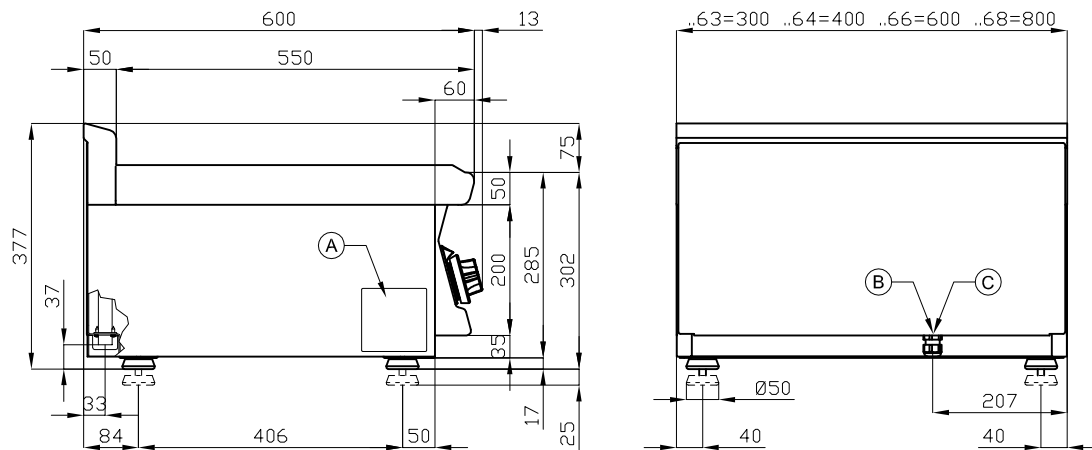

A	Data plate	C	Gas connection	ISO 7-1 1/2" M
---	------------	---	----------------	----------------

MODEL: FTLT-66G
DIMENSIONS: cm. 60x 60x 28h
GAS POWER: 9 kW / 7.740 kcal/h
GAS TYPE: Natural Gas / LPG



kg: 65
m³: 0.283
mm: 630x690x650

BUY LOTUS BUY ITALY

The pictures are purely representative. The manufacturer reserves the right to modify the technical data and models without previous notice.



LOTUS S.P.A. Via Calmaor, 46
31020 San Vendemiano(TV) - Italy
Tel. + 39 0438 778020 / 778468
Fax + 39 0438 778277
www.lotuscookers.it - lotus@lotuscookers.it