



REACH IN FREEZER

Z55AF

Top Mounted / 2-Solid Door













i TECHNICAL SPECIFICATIONS

Voltage/Frequency 220V/50Hz
Refrigerant R290
Type of Defrost Automatic
Interior Material Stainless Steel
Exterior Material Stainless Steel
Temperature Range °F 0 ~ -8°F
Compressor Power (HP) 1-
Nema Config. NEMA5-15P



PRODUCT FEATURES

-  The compressor is mounted in the top and placed in the coolest possible area; this makes it easily accessible for servicing.
-  Digital temperature controls with LED display for precise adjustment and automatic defrosting system.
-  Temperatures in the cabinet range from 0 to -8 degrees Fahrenheit
-  Self closing doors with stay open feature.
-  R290 Natural Refrigerant promotes faster cool down and efficient energy consumption.
-  Epoxy coated wire shelves.
-  Stainless steel interior & exterior, sealed interior floors, and rounded cabinet corners for easy cleaning.
-  High quality coated stainless adjustable shelves prevent peel and rust.
-  Lifetime warranty on hinges.
-  Adjustable front locking casters.



HIGH QUALITY STAINLESS STEEL & ROBUST DESIGN



Los Angeles | San Francisco | Dallas
Houston | Florida | Chicago | New Jersey

+1(708) 590-9543

info@zuilex.com

www.zuilex.com

DETAILS & SPECIFICATIONS

Z55AF

Front View

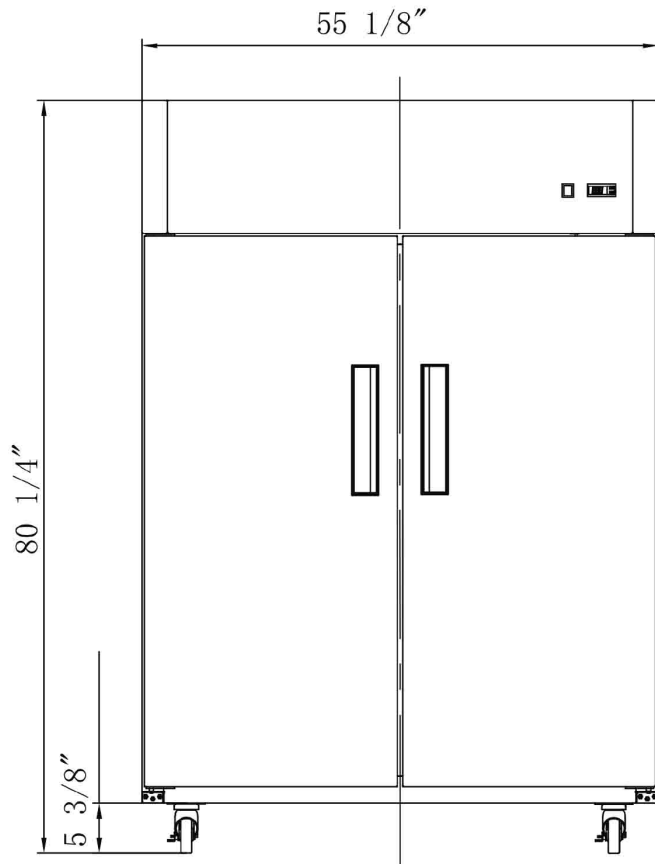

Side View

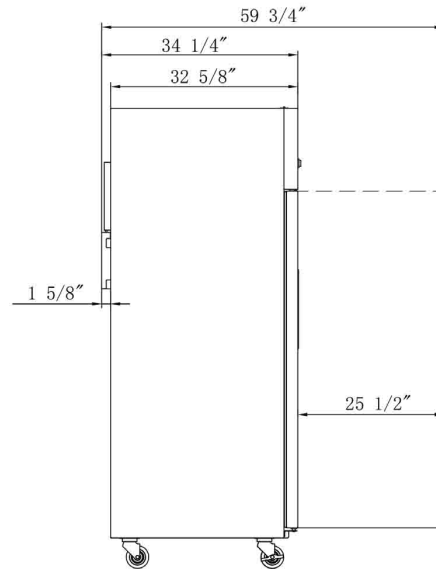

| | |
|---------------------------|--------------|
| Rated Voltage | 220V |
| Rated Frequency | 50Hz |
| Total Input Power | 1250W |
| Total Current | 11.8 A |
| Total Capacity | 41.73 cu ft |
| Climatic Category | 4-5 |
| Protection Type | I |
| Design Pressure High Side | 300 PSIG |
| Design Pressure Low Side | 150 PSIG |
| Insulation Blowing Gas | C-Pentane |
| Refrigerant | R290/5.11 oz |

| MODEL | EXTERNAL DIMENSION WXDXH (INCHES) | PACKAGING DIMENSION WXDXH (INCHES) | PRODUCT NET WEIGHT | # OF SHELVES | 40HQ CONTAINER CERT. |
|-------|--------------------------------------|---------------------------------------|-----------------------|-----------------|-------------------------|
| Z55AF | 55 1/8 x 34 1/4 x 80 1/4 | 57 1/8 x 35 1/4 x 82 1/4 | 463 lbs | 8 | 16 |



Los Angeles | San Francisco | Dallas
Houston | Florida | Chicago | New Jersey

+1(708) 590-9543

info@zuilex.com

www.zuilex.com