



**PREMIUM
WARRANTY**

REACH IN FREEZER

Z83AF

Top Mounted / 3-Solid Door













i TECHNICAL SPECIFICATIONS

Voltage/Frequency 220V/50Hz
Refrigerant R290
Type of Defrost Automatic
Interior Material Stainless Steel
Exterior Material Stainless Steel
Temperature Range °F 0 ~ -8°F
Compressor Power (HP) 3/4+3/4
Nema Config. NEMA5-20P



PRODUCT FEATURES

-  The compressor is mounted in the top and placed in the coolest possible area; this makes it easily accessible for servicing.
-  Digital temperature controls with LED display for precise adjustment and automatic defrosting system.
-  Temperatures in the cabinet range from 0 to -8 degrees Fahrenheit
-  Self closing doors with stay open feature.
-  R290 Natural Refrigerant promotes faster cool down and efficient energy consumption.
-  Epoxy coated wire shelves.
-  Stainless steel interior & exterior, sealed interior floors, and rounded cabinet corners for easy cleaning.
-  High quality coated stainless adjustable shelves prevent peel and rust.
-  Lifetime warranty on hinges.
-  Adjustable front locking casters.



HIGH QUALITY STAINLESS STEEL & ROBUST DESIGN



Los Angeles | San Francisco | Dallas
Houston | Florida | Chicago | New Jersey

 +1(708) 590-9543

 info@zuilex.com

 www.zuilex.com

DETAILS & SPECIFICATIONS

Z83AF

Front View

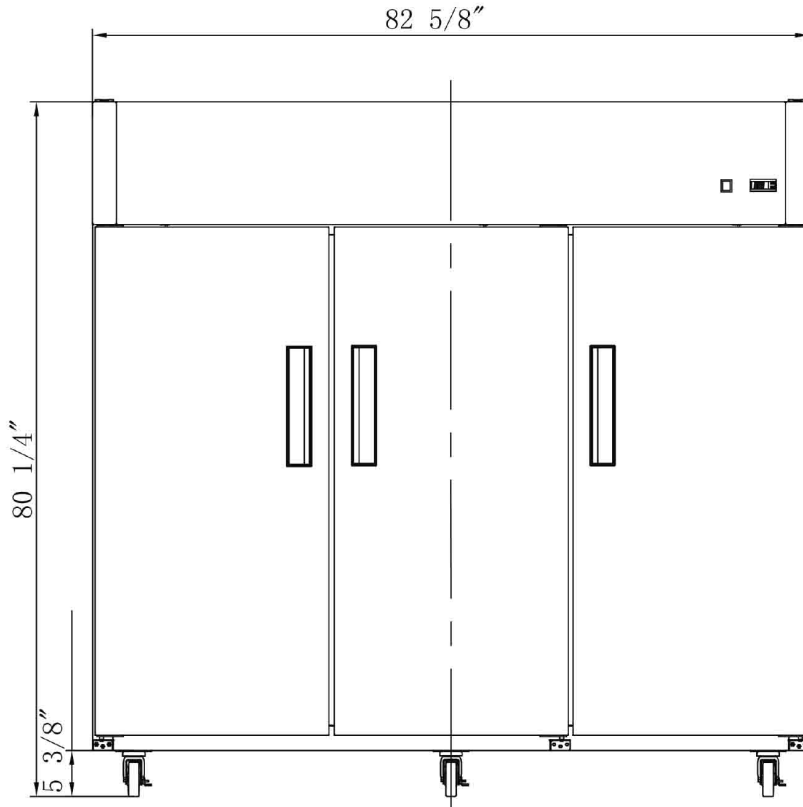

Side View

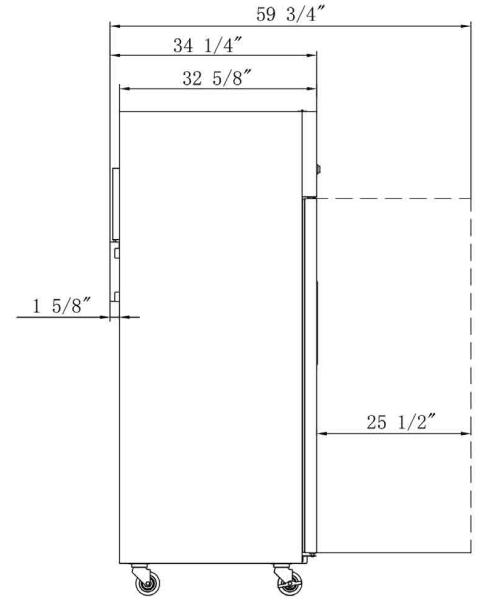

Rated Voltage	220 V
Rated Frequency	50 Hz
Total Input Power	1300W
Total Current	16A
Total Capacity	65.98cu ft
Climatic Category	4-5
Protection Type	I
Design Pressure High Side	300 PSIG
Design Pressure Low Side	150 PSIG
Insulation Blowing Gas	C-Pentane
Refrigerant	R290/4.2+4.2 oz

MODEL	EXTERNAL DIMENSION WXDXH (INCHES)	PACKAGING DIMENSION WXDXH (INCHES)	PRODUCT NET WEIGHT	# OF SHELVES	40HQ CONTAINER CERT.
Z83AF	82 5/8 x 34 1/4 x 80 1/4	84 5/8 x 35 1/4 x 82 1/4	595 lbs	12	13



Los Angeles | San Francisco | Dallas
Houston | Florida | Chicago | New Jersey

+1(708) 590-9543

info@zuilex.com

www.zuilex.com