

# BR80-98GF/I

90 IPERLOTUS

GAS TILTING BRATTPANS

Braising pan with manual tilting, bowl 80 lt.  
cm.72x56x22,5h, Stainless steel bottom with  
lid



Construction - Fabricated using CrNi 18/10 AISI 304 grade Stainless Steel Scotch-Brite Satin polish Finish, incorporating 2mm thick worktop, rounded edges, chromed details and rear splash back. Tanks bottom in stainless steel. Knobs with waterproof grades IPX5. Model - Professional Gas Tilting Bratt Pan (80°) with highly accurate manual or motorised 80 - 120ltr tank with highly efficient conductive base. Water tap and hinged cover, thermostatically controlled up to 300deg C. Piezoelectric ignition on manual tilt and electrical control on motorised, pilot light. Thermostatic control and thermocouple safety valves. Fittings - Appliance is supplied with both LPG and Natural Gas conversion jets and adjustable feet.



ITALIAN CULINARY ART

The pictures are purely representative. The manufacturer reserves the right to modify the technical data and models without previous notice.

# BR80-98GF/I

90 IPERLOTUS

GAS TILTING BRATTPANS

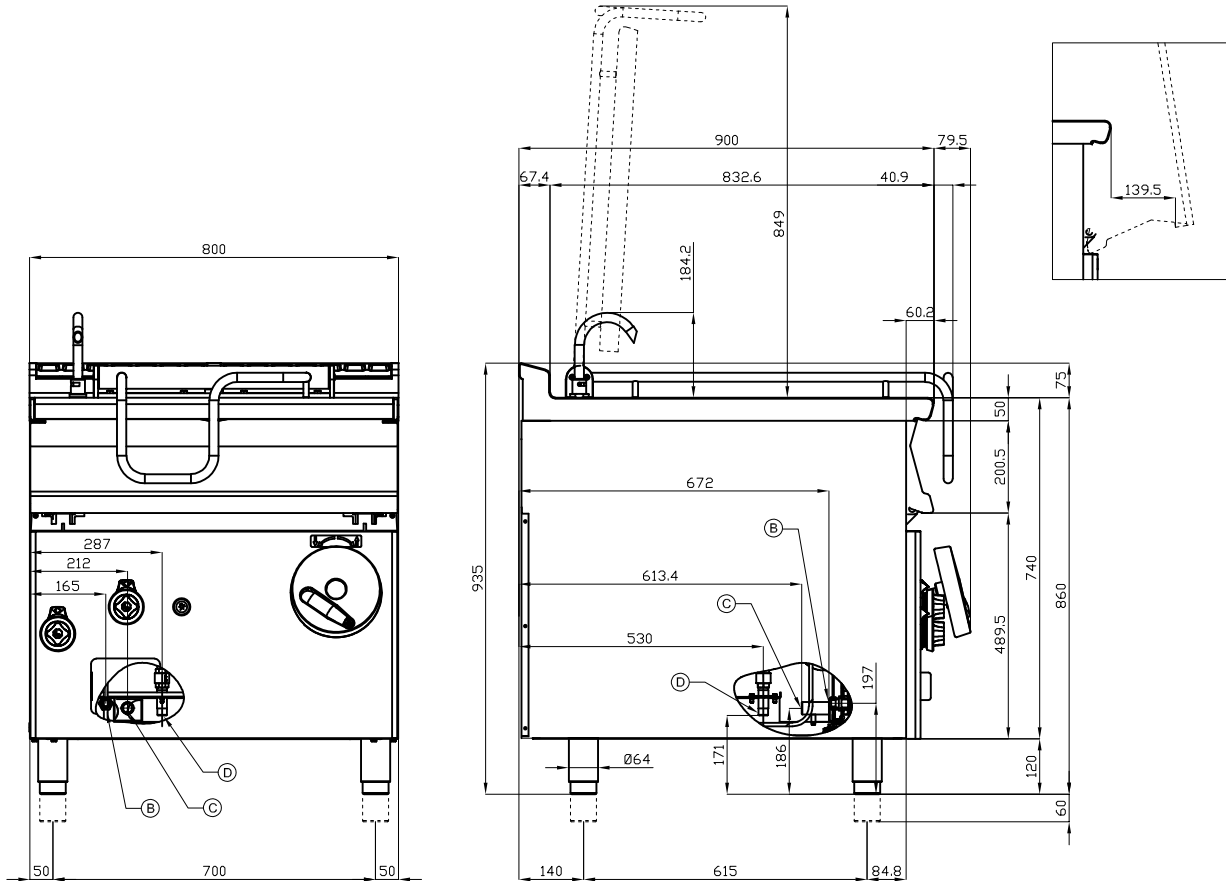

A	Data plate		C	Gas connection	ISO 7-1 3/4" M
D	Cold water connection	ISO 7-1 1/2" M			

MODEL: BR80-98GF/I  
 DIMENSIONS: cm. 80x 90x 90h  
 GAS POWER: 22 kW / 18.920 kcal/h  
 GAS TYPE: Natural Gas / LPG



kg: 159  
 m<sup>3</sup>: 0.894  
 mm: 830x970x1110

BUY LOTUS BUY ITALY

The pictures are purely representative. The manufacturer reserves the right to modify the technical data and models without previous notice.



LOTUS S.P.A. Via Calmaor, 46  
 31020 San Vendemiano(TV) - Italy  
 Tel. + 39 0438 778020 / 778468  
 Fax + 39 0438 778277  
 www.lotuscookers.it - lotus@lotuscookers.it